

TECHNICAL CATALOGUE

MONO SPLIT

RAK-25RXB
RAK-35RXB
RAK-50RXB



RAC-25WXB
RAC-35WXB



RAC-50WXB



HITACHI

Specifications in this catalogue are subject to change without prior notice in order for HITACHI to bring in the latest innovations to their customers

Whilst every effort is made to ensure that all dimensions and specifications are correct, any printers' error not rectified are outside the control of HITACHI, who cannot be held responsible for the same

CONTENTS

CONTENTS	1
1 SPECIFICATIONS	3
1.1. WALL TYPE (RAK-25RXB/35RXB/50RXB)	3
1.2. WALL TYPE (RAC-25WXB/35WXB/50WXB)	4
2 DIMENSIONAL DATA	5
2.1. WALL TYPE: RAK-25RXB/35RXB/50RXB	5
2.2. WALL TYPE: RAC-25WXB/35WXB	6
2.3. WALL TYPE: RAC-50WXB	7
3 CAPACITIES TABLE	8
3.1. CAPACITY CHARACTERISTIC CURVES	8
3.1.1. RAK-25RXB/RAC-25WXB	8
3.1.2. RAK-35RXB/RAC-35WXB	8
3.1.3. RAK-50RXB/RAC-50WXB	9
3.2. CORRECTION FACTORS ACCORDING TO PIPING LENGTH	10
3.3. CORRECTION FACTORS ACCORDING TO DEFROSTING OPERATION	12
4 SOUND DATA	13
4.1. RAC-25WXB	13
4.2. RAC-35WXB	14
4.3. RAC-50WXB	15
5 WORKING RANGE	16
5.1. POWER SUPPLY	16
5.2. WORKING RANGE	16
6 ELECTRICAL DATA	17
6.1. INDOOR UNIT	17
6.2. OUTDOOR UNIT	17
7 WIRING DIAGRAM	18
7.1. RAK-25RXB, RAK-35RXB, RAK-50RXB	18
7.2. RAC-25WXB, RAC-35WXB	19
7.3. RAC-50WXB	20
8 REFRIGERANT CYCLE	21
8.1. WALL TYPE: RAK-25RXB/RAC-25WXB, RAK-35RXB/RAC-35WXB	21
8.2. WALL TYPE: RAK-50RXB / RAC-50WXB	21
9 CONTROL AND FUNCTION	22
9.1. WIRELESS REMOTE CONTROL FUNCTION	22
9.2. AUTO CHANGEOVER	23
9.3. SHIFT VALUE	23
9.4. OPERATION LOCK	24
9.5. SETTING THE PREVENTION OF MUTUAL INTERFERENCE	24
9.6. INTERMITTENT FAN SPEED SETTING	25
9.7. FAN SPEED SETTING IN THERMO OFF IN COOLING	26
9.8. ERROR CODE INFORMATION	27
9.9. ADDITIONAL FUNCTION VIA DIP-SWITCH SETTINGS	29
9.9.1. AUTO RESTART FUNCTION	29
9.9.2. HEATING/COOLING ONLY MODEL SELECTION	29

10	OPTION LIST	30
10.1.	WIRED REMOTE CONTROL – SPX-RCDB	30
10.1.1.	SHIFT VALUE	30
10.1.2.	ERROR CODE INFORMATION	31
10.2.	H-LINK ADAPTOR – PSC 6RAD	34
10.2.1.	SAFETY SUMMARY	34
10.2.2.	INSTALLATION WORK	34
10.2.3.	ELECTRICAL WIRING	35
10.2.4.	DIP SWITCH SETTING	36
10.2.5.	TEST RUN	37
10.3.	DRY CONTACT (SPX-WDC3) APPLICATION (USING DIP SWITCH)	38
10.4.	DISTRIBUTOR – SPX-DST1	40

1 SPECIFICATIONS

1.1. WALL TYPE (RAK-25RXB/35RXB/50RXB)

INDOOR	UNIT	RAK-25RXB	RAK-35RXB	RAK-50RXB
Nominal capacity adjustable		no	no	no
Nominal Cooling capacity (min - max)	kW	2.50 (0.90 - 3.10)	3.50 (0.90 - 4.00)	5.00 (1.90 - 5.20)
Cooling sensible capacity	kW	2.3	3.0	3.7
Nominal Heating capacity (min - max)	kW	3.20 (0.90 - 4.20)	4.00 (0.90 - 4.80)	5.80 (2.2 - 7.00)
Noise level cooling (sound pressure) (SL / L / M / H)	dB(A)	20/26/32/40	22/29/35/42	25/31/39/47
Noise level heating (sound pressure) (SL / L / M / H)	dB(A)	20/27/33/40	22/30/35/42	25/31/39/48
Noise level (sound power)	dB(A)	55	60	60
Air flow cooling mode (SL / L / M / H)	m ³ /h	300/330/510/560	320/340/430/580	350/400/580/720
Air flow heating mode (SL / L / M / H)	m ³ /h	290/370/560/610	310/360/480/630	350/420/620/800
Fan Motor	W	30	30	30
Dehumidification	l/h	1.4	1.6	2
Dimensions (H x W x D)	mm	295 x 900 x 210	295 x 900 x 210	295 x 900 x 210
Weight	kg	11	11	11
Colour		White (N9.5)	White (N9.5)	White (N9.5)
Condensate Drain	mm	φ16	φ16	φ16
Running current (C/H)	A	1.09-5.30 / 1.09-5.22	1.09-6.09 / 1.09-6.96	2.17-9.13 / 2.17-11.74
Power supply		230V / 1Ph / 50Hz	230V / 1Ph / 50Hz	230V / 1Ph / 50Hz
Cable section (Interconnection)	mm ²	1.50 x 3 + EARTH	1.50 x 3 + EARTH	2.50 x 3 + EARTH
Piping diameter (Liq / Gas)	Inch	1/4" / 3/8"	1/4" / 3/8"	1/4" / 1/2"
Drain diameter (ext)	mm	φ16	φ16	φ16
Remote control (standard/optional)		RAR-6N1/ SPX-RCDB	RAR-6N1/ SPX-RCDB	RAR-6N1/ SPX-RCDB
Filter				
ACL Filter		Wasabi	Wasabi	Wasabi
ACL part name		SPX-CFH22	SPX-CFH22	SPX-CFH22
Pre-filter (Standard/Optional)		Stainless/-	Stainless/-	Stainless/-

NOTE:

1. The nominal cooling and heating capacity is the combined capacity of the HITACHI standard split system, and are based on the ISO 5151.

Operation Conditions		Cooling	Heating
Indoor Air Inlet Temperature	dB	27.0 °C	20.0 °C
	WB	19.0 °C	
Outdoor Air Inlet Temperature	dB	35.0 °C	7.0 °C
	WB		6.0 °C

Piping Length: 5.0 meters; **Piping Lift:** 0 meter
dB: Dry Bulb; **WB:** Wet Bulb

2. The Sound Pressure Level is based on the following conditions:

- 0.8 meter beneath indoor height center
- 1 meter from Discharge grille

The above data was measured in an anechoic chamber. Please take into consideration reflected sound of your specific site

1.2. WALL TYPE (RAC-25WXB/35WXB/50WXB)

OUTDOOR	UNIT	RAC-25WXB	RAC-35WXB	RAC-50WXB
Nominal Cooling capacity (min - max)	kW	2.50 (0.90 - 3.10)	3.50 (0.90 - 4.00)	5.00 (1.90 - 5.20)
Nominal Heating capacity (min - max)	kW	3.20 (0.90 - 4.20)	4.00 (0.90 - 4.80)	5.80 (2.2 - 7.00)
Nominal cooling power input (min - max)	kW	0.545 (0.25 - 1.22)	0.910 (0.25 - 1.40)	1.560 (0.50 - 2.10)
Nominal heating power input (min - max)	kW	0.700 (0.25 - 1.20)	0.955 (0.25 - 1.60)	1.560 (0.50 - 2.70)
EER / COP		4.59/4.57	3.85/4.19	3.21/3.72
SEER / SCOP		8.50/4.70	8.50/4.72	7.20/4.50
Energy class (SEER/SCOP)		A+++/A++	A+++/A++	A++/A+
Noise level cooling (sound pressure)	dB(A)	46	47	51
Noise level heating (sound pressure)	dB(A)	47	49	51
Noise level (sound power)	dB(A)	60	61	65
Air flow (Cooling / Heating)	m ³ /h	1860 / 1620	1920 / 1620	2160 / 2160
Dimensions (H x W x D)	mm	548x750x288	548x750x288	736x800x350
Weight	kg	34	34	49.5
Colour		Beige (5Y7/2)	Beige (5Y7/2)	Beige (5Y7/2)
Power supply		230V / 1Ph / 50Hz	230V / 1Ph / 50Hz	230V / 1Ph / 50Hz
Recommended fuse size	A	15	15	25
Starting current (C/H)	A	3.68/3.85	4.72/4.93	7.12/7.45
Running current (C/H)	A	1.09-5.30/1.09-5.22	1.09-6.09/1.09-6.96	2.17-9.13/2.17-11.74
Cable section (power)	mm ²	1.50x 2+EARTH	1.50x 2+EARTH	2.50x 2+EARTH
Cable section (Interconnection)	mm ²	1.50x 3+EARTH	1.50x 3+EARTH	2.50x 3+EARTH
Piping diameter (Liq / Gas)		1/4" / 3/8"	1/4" / 3/8"	1/4" / 1/2"
Minimum piping length	m	3	3	3
Maximum piping length / height difference	m	20 / 10	20 / 10	30 / 10
Current quantity of refrigerant / Chargeless	kg	1.08	1.17	1.35
Chargeless / Additional refrigerant charge	m / g/m	20/-	20/-	30/-
Working range (cooling / heating)	°C	-10°C-43°C/ -15°C-21°C	-10°C-43°C/ -15°C-21°C	-10°C-43°C/ -15°C-21°C
Refrigerant		R410A	R410A	R410A
Condenser Fan		Propeller Fan	Propeller Fan	Propeller Fan
Compressor	Type		ROTARY	ROTARY
	Oil Charge	mL	320±20	320±20
	Oil Type		α68HES-H or equivalent	α68HES-H or equivalent
	Coil Resistance	Ω	1.625 at 20°C	1.625 at 20°C
	Quantity		1	1

NOTE:

1. The Sound Pressure Level is based on the following conditions:

- 1 meter from the unit front surface and 1 meter from floor level

The above data was measured in an anechoic chamber. Please take into consideration reflected sound of your specific site

2 DIMENSIONAL DATA

2.1. WALL TYPE: RAK-25RXB/35RXB/50RXB

Unit : mm

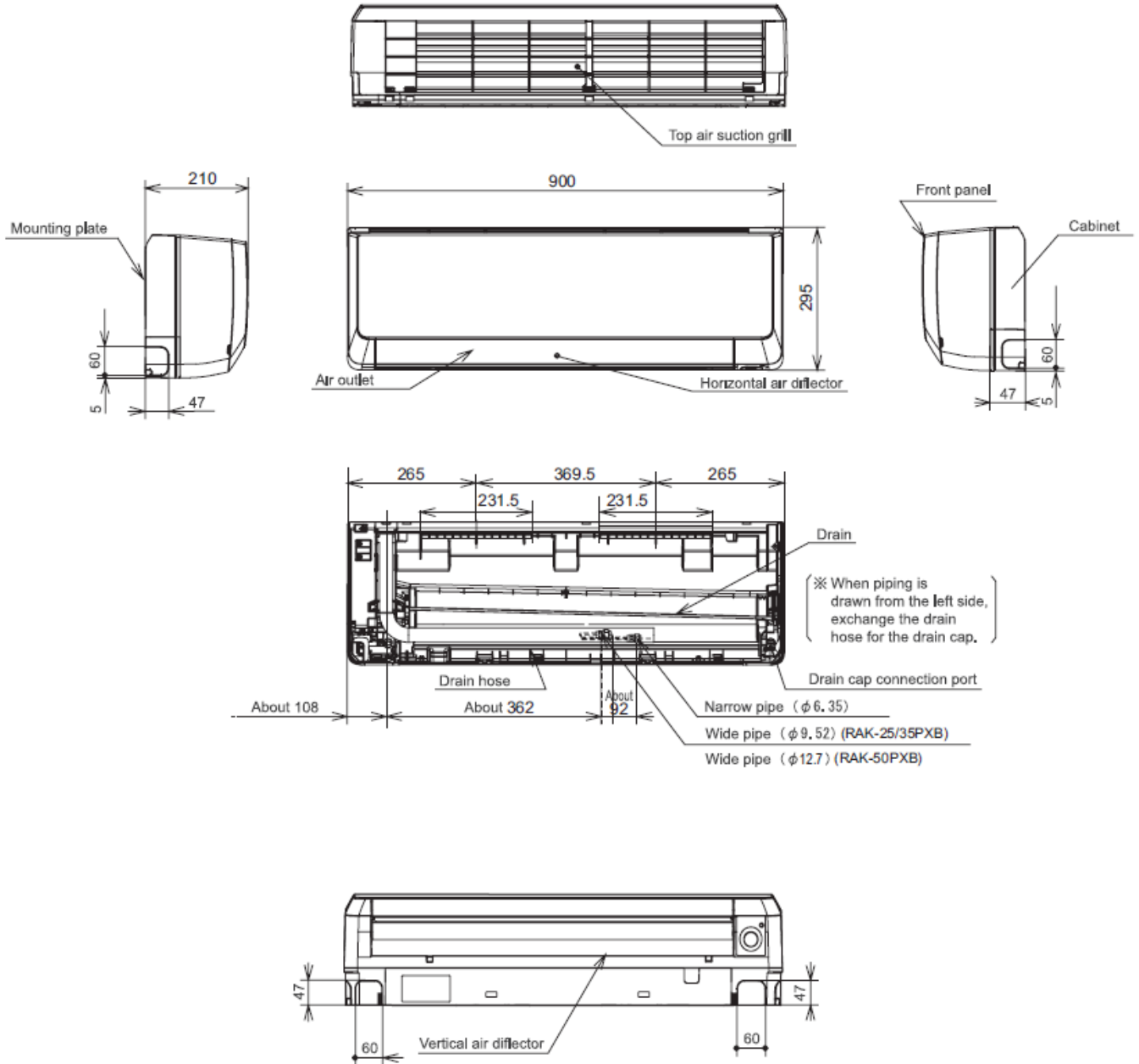

2.2. WALL TYPE: RAC-25WXB/35WXB

Unit: mm

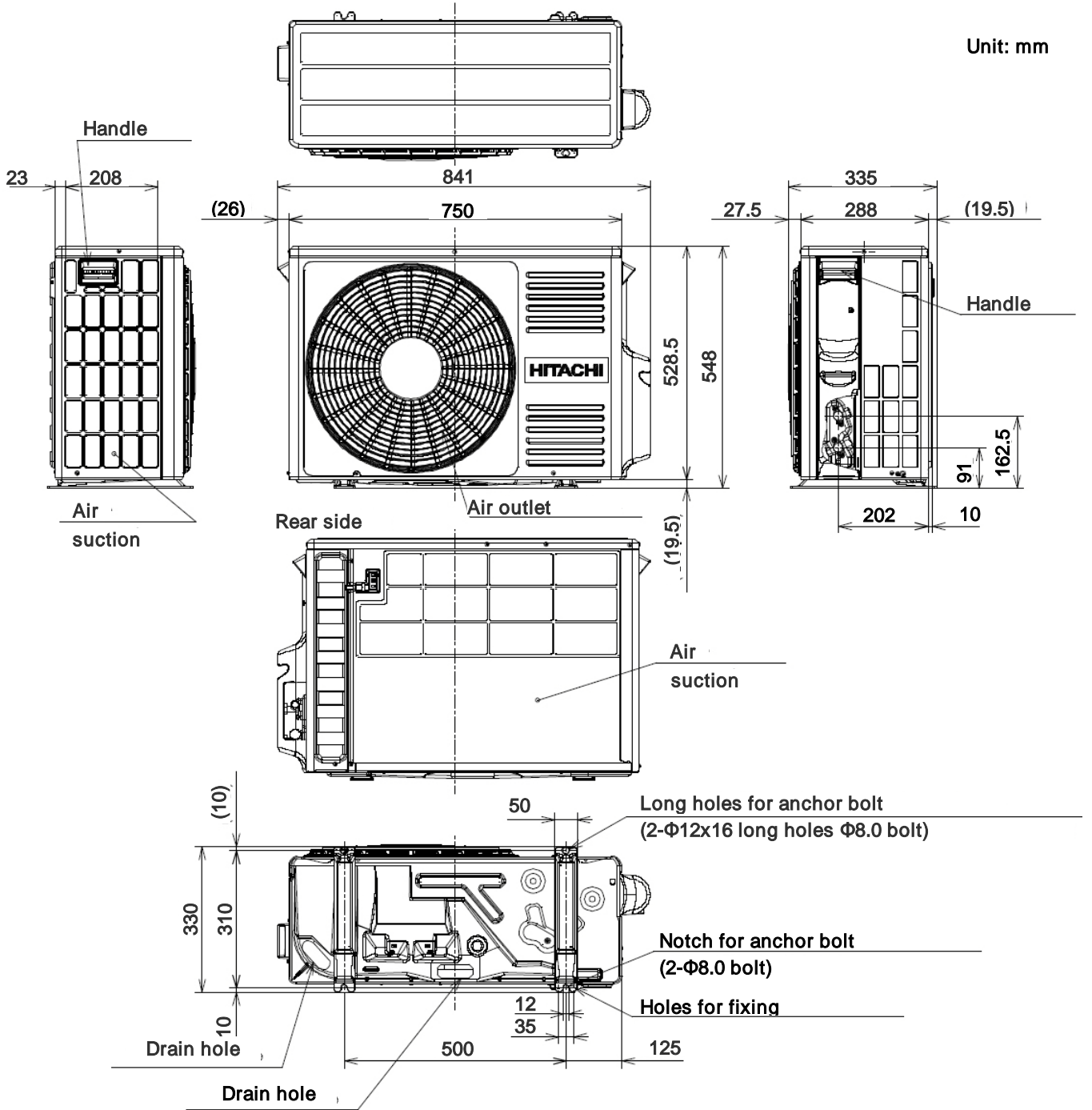

2.3. WALL TYPE: RAC-50WXB

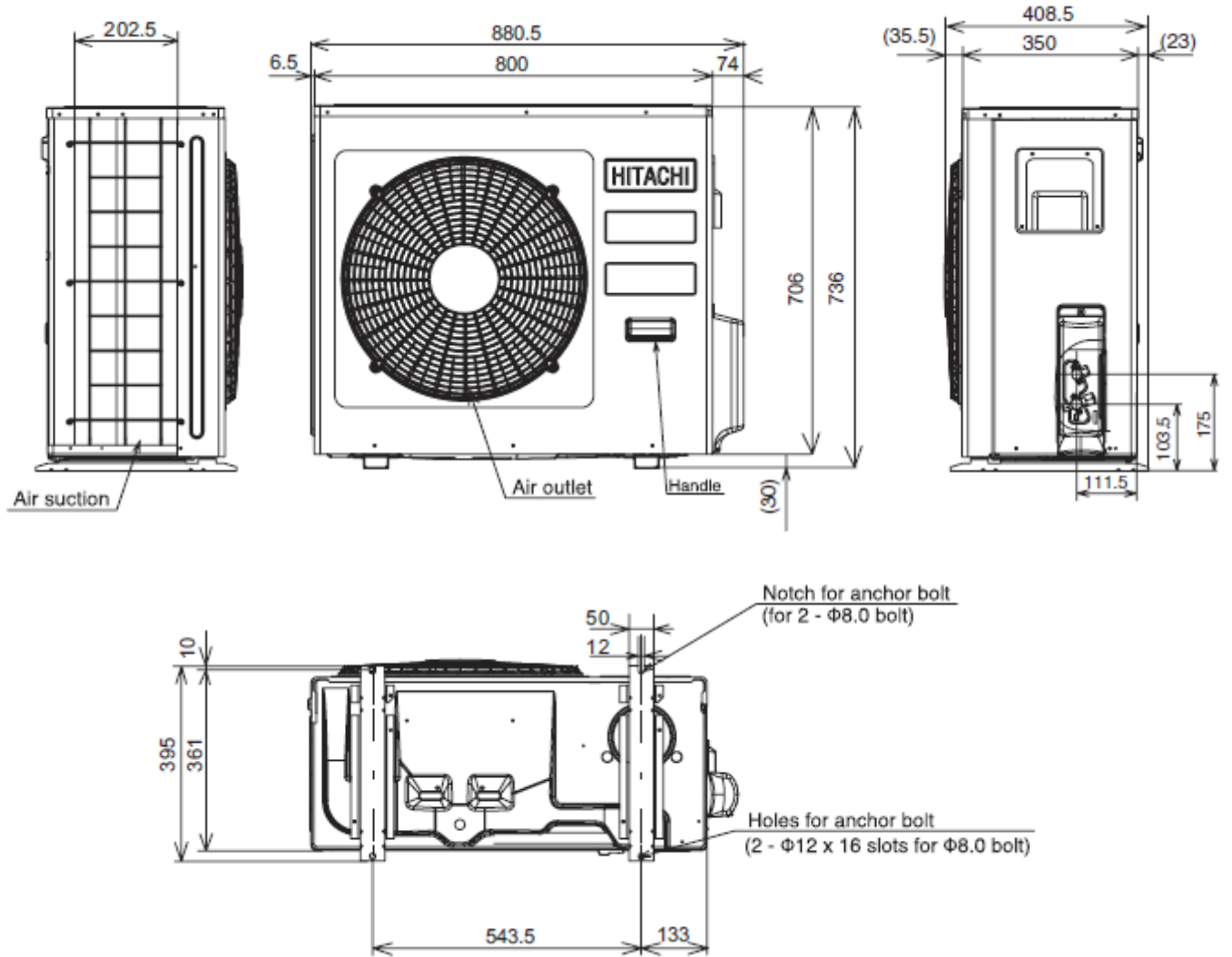

3 CAPACITIES TABLE

3.1. CAPACITY CHARACTERISTIC CURVES

The following charts show the characteristics of outdoor unit capacity, which corresponds with the operating ambient temperature of outdoor unit.

Condition:

① Pipe length / height difference : 5m / 0m

③ Capacity loss due to white frost and defrost operation is not included.

② Indoor fan speed at High mode

3.1.1. RAK-25RXB/RAC-25WXB

COOLING [50Hz, 230V]

INDOOR		OUTDOOR TEMPERATURE (°CDB)																				
EWB	EDB	-10			21			27			32			35			40			43		
		°C	°C	TC	SHC	PI	TC	SHC	PI	TC	SHC	PI	TC	SHC	PI	TC	SHC	PI	TC	SHC	PI	
12.0	18	2008	1857	314	2350	2558	385	2175	2362	454	2050	2239	501	1975	2140	523	1850	2017	561	1775	1919	583
14.0	20	2008	1857	314	2525	2558	385	2350	2386	459	2200	2239	507	2125	2165	529	1975	2017	567	1900	1943	594
16.0	22	2008	1976	319	2700	2558	390	2500	2386	465	2350	2239	512	2275	2165	540	2125	2017	578	2050	1943	600
18.0	25	2153	2119	324	2875	2780	395	2650	2583	470	2500	2435	518	2400	2337	540	2250	2189	583	2150	2091	605
19.0	27	2226	2190	329	2975	2927	400	2750	2706	475	2600	2558	523	2500	2460	545	2350	2312	583	2250	2214	605
22.0	30	2468	2166	329	3300	2903	400	3050	2681	475	2875	2534	529	2775	2435	550	2500	2362	605	2325	2312	638
24.0	32	2637	2166	334	3525	2903	405	3250	2681	481	3075	2534	529	2950	2435	556	2600	2411	621	2375	2386	659

HEATING [50Hz, 230V]

INDOOR		OUTDOOR TEMPERATURE (°CDB)																							
EDB	°C	-15			-10			-7			-5			0			7			10			15		
		TC	SHC	PI	TC	SHC	PI	TC	SHC	PI	TC	SHC	PI	TC	SHC	PI	TC	SHC	PI	TC	SHC	PI			
16	2068		824	2662		837	3010		852	3025		839	3074		795	3163		755	3521		766	4091		785	
18	2084		817	2678		830	3030		841	3048		825	3099		780	3182		727	3539		737	4120		753	
20	2100		810	2694		823	3050		830	3071		811	3125		765	3200		700	3556		708	4150		720	
22	2116		803	2710		816	3070		819	3095		798	3151		750	3218		673	3574		678	4180		687	
24	2132		796	2726		809	3090		808	3118		784	3176		735	3237		645	3591		649	4209		655	

3.1.2. RAK-35RXB/RAC-35WXB

COOLING [50Hz, 230V]

INDOOR		OUTDOOR TEMPERATURE (°CDB)																				
EWB	EDB	-10			21			27			32			35			40			43		
		°C	°C	TC	SHC	PI	TC	SHC	PI	TC	SHC	PI	TC	SHC	PI	TC	SHC	PI	TC	SHC	PI	
12.0	18	1816	1433	339	2193	2038	429	2030	1882	505	2870	2675	837	2765	2558	874	2590	2411	937	2485	2293	974
14.0	20	1816	1433	339	2357	2038	429	2193	1901	511	3080	2675	846	2975	2587	883	2765	2411	946	2660	2323	992
16.0	22	1816	1525	344	2520	2038	434	2333	1901	517	3290	2675	855	3185	2587	901	2975	2411	965	2870	2323	1001
18.0	25	1947	1635	349	2683	2215	440	2473	2058	523	3500	2911	865	3360	2793	901	3150	2617	974	3010	2499	1010
19.0	27	2013	1691	354	2777	2332	446	2567	2156	529	3640	3058	874	3500	2940	910	3290	2764	974	3150	2646	1010
22.0	30	2231	1672	354	3080	2313	446	2847	2136	529	4025	3028	883	3885	2911	919	3500	2822	1010	3255	2764	1065
24.0	32	2384	1672	360	3290	2313	451	3033	2136	535	4305	3028	883	4130	2911	928	3640	2881	1037	3325	2852	1101

EWB : Evaporator Wet Bulb temperature (°C)

EDB : Evaporator Dry Bulb temperature (°C)

(°CDB) : Outdoor Unit Inlet Air Dry Temperature (°C)

TC : Total Capacity (W)

SHC : Sensible Heating Capacity (W)

PI : Power Input

HEATING [50Hz, 230V]

INDOOR		OUTDOOR TEMPERATURE (°CDB)																							
EDB		-15			-10			-7			-5			0			7			10			15		
°C	TC	SHC	PI	TC	SHC	PI	TC	SHC	PI	TC	SHC	PI	TC	SHC	PI	TC	SHC	PI	TC	SHC	PI	TC	SHC	PI	
16	2960		1189	3710		1314	4150		1400	4113		1348	4036		1203	3954		1030	4406		1109	5126		1244	
18	2980		1180	3730		1305	4175		1385	4142		1330	4068		1183	3977		992	4428		1070	5163		1199	
20	3000		1170	3750		1295	4200		1370	4171		1311	4100		1163	4000		955	4450		1030	5200		1155	
22	3020		1160	3770		1285	4225		1355	4200		1292	4132		1142	4023		918	4472		990	5237		1111	
24	3040		1151	3790		1276	4251		1340	4229		1273	4164		1122	4046		880	4494		951	5274		1066	

3.1.3. RAK-50RXB/RAC-50WXB**COOLING [50Hz, 230V]**

INDOOR		OUTDOOR TEMPERATURE (°CDB)																							
EWB	EDB	-10			21			27			32			35			40			43					
°C	°C	TC	SHC	PI	TC	SHC	PI	TC	SHC	PI	TC	SHC	PI	TC	SHC	PI	TC	SHC	PI	TC	SHC	PI	TC	SHC	PI
12.0	18	2621	1640	586	3067	2260	720	2839	2086	848	4100	3030	1435	3950	2897	1498	3700	2731	1607	3550	2597	1669			
14.0	20	2621	1640	586	3296	2260	720	3067	2108	858	4400	3030	1451	4250	2930	1513	3950	2731	1622	3800	2631	1700			
16.0	22	2621	1746	596	3524	2260	729	3263	2108	868	4700	3030	1466	4550	2930	1544	4250	2731	1654	4100	2631	1716			
18.0	25	2811	1872	605	3753	2456	739	3459	2282	878	5000	3297	1482	4800	3164	1544	4500	2964	1669	4300	2831	1732			
19.0	27	2905	1935	614	3883	2586	748	3589	2391	888	5200	3463	1498	5000	3330	1560	4700	3130	1669	4500	2997	1732			
22.0	30	3221	1914	614	4307	2564	748	3981	2369	888	5750	3430	1513	5550	3297	1576	5000	3197	1732	4650	3130	1825			
24.0	32	3442	1914	623	4601	2564	757	4242	2369	898	6150	3430	1513	5900	3297	1591	5200	3263	1778	4750	3230	1888			

HEATING [50Hz, 230V]

INDOOR		OUTDOOR TEMPERATURE (°CDB)																							
EDB		-15			-10			-7			-5			0			7			10			15		
°C	TC	SHC	PI	TC	SHC	PI	TC	SHC	PI	TC	SHC	PI	TC	SHC	PI	TC	SHC	PI	TC	SHC	PI	TC	SHC	PI	
16	3792		1591	4698		1704	5227		1789	5287		1776	5457		1716	5733		1682	6280		1757	7143		1885	
18	3821		1576	4727		1688	5263		1765	5329		1745	5504		1683	5767		1621	6312		1692	7196		1813	
20	3850		1560	4756		1673	5300		1740	5371		1714	5550		1650	5800		1560	6344		1628	7250		1740	
22	3879		1544	4785		1657	5337		1715	5413		1683	5596		1617	5833		1499	6376		1563	7304		1667	
24	3908		1529	4814		1641	5373		1691	5456		1653	5643		1584	5867		1438	6408		1498	7357		1595	

EWB : Evaporator Wet Bulb temperature (°C)
 EDB : Evaporator Dry Bulb temperature (°C)
 (°CDB) : Outdoor Unit Inlet Air Dry Temperature (°C)

TC : Total Capacity (W)
 SHC : Sensible Heating Capacity (W)
 PI : Power Input

3.2. CORRECTION FACTORS ACCORDING TO PIPING LENGTH

Correction Factor for **Cooling Capacity** according to Piping Length

The cooling capacity should be corrected according to the following formula:

$$CCA = CC \times F$$

- CCA: Actual Corrected Cooling Capacity (kcal/h)
- CC: Cooling Capacity in the Performance Table (kcal/h)
- F: Correction Factor Based on the Equivalent Piping Length

Correction Factor for **Heating Capacity** according to Piping Length

The heating capacity should be corrected according to the following formula:

$$HCA = HC \times F$$

- HCA: Actual Corrected Heating Capacity (kcal/h)
- HC: Heating Capacity in the Performance Table (kcal/h)
- F: Correction Factor Based on the Equivalent Piping Length

The correction factors are shown in the following figure.

Equivalent Piping Length for:

- One 90° Elbow is 0.5m.
- One 180° Curve is 1.5m.

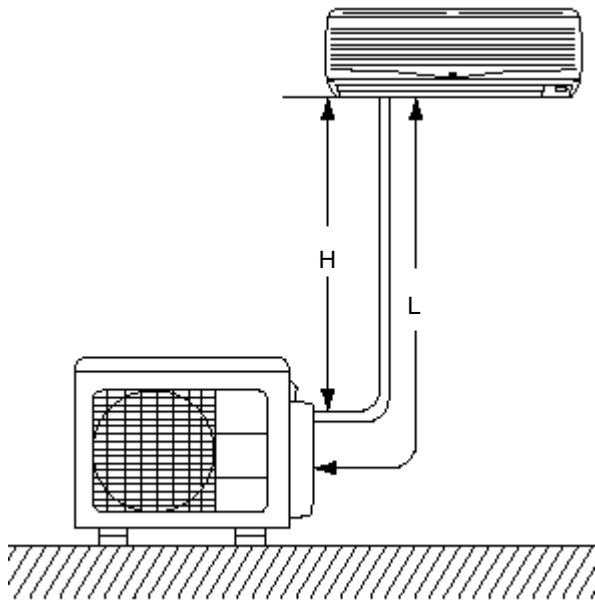

- H: Vertical Distance Between Indoor Unit and Outdoor Units in Meters
- L: Actual One-Way Piping Length Between Indoor Unit and Outdoor Unit in Meters
- EL: Equivalent Total Distance Between Indoor Unit and Outdoor Unit in Meters (Equivalent One-Way Piping Length)

Models : RAK-25RXB/RAC-25WXB, RAK-35RXB/RAC-35WXB

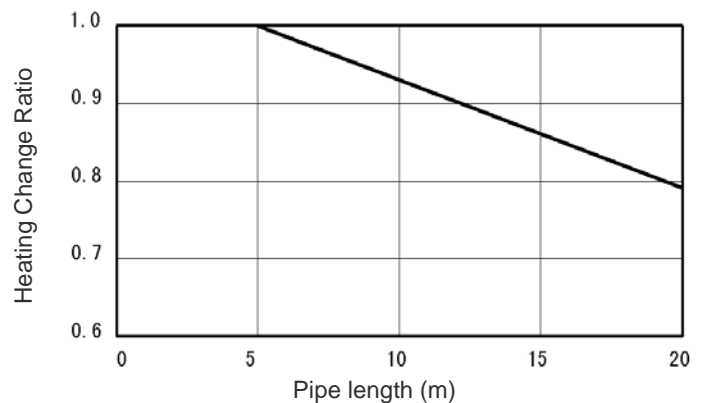
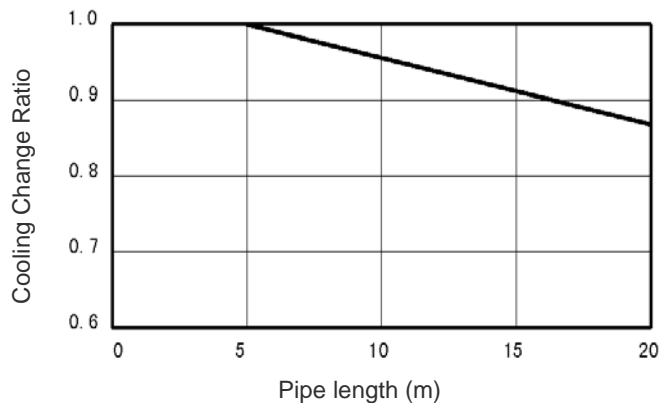

Models : RAK-50RXB/RAC-50WXB

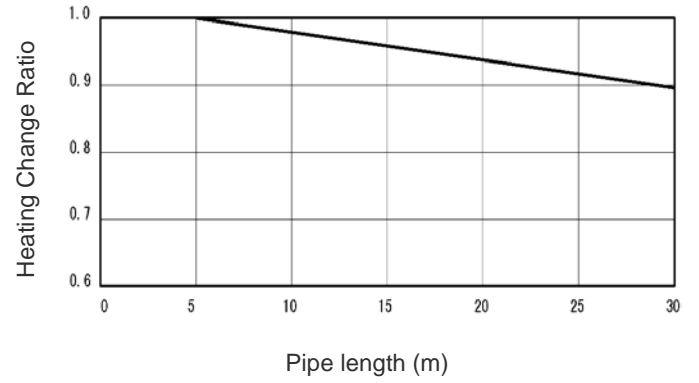
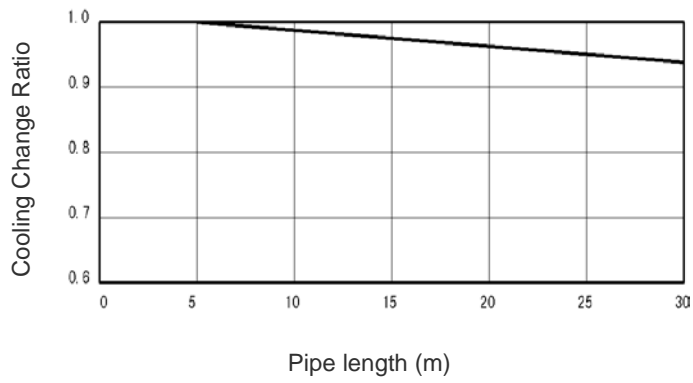

3.3. CORRECTION FACTORS ACCORDING TO DEFROSTING OPERATION

The heating capacity in the preceding paragraph, excludes the condition of the frost or the defrosting operation period. In consideration of the frost or the defrosting operation, the heating capacity is corrected by the equation below.

$$\text{Corrected heating capacity} = \text{Defrost Correction factor} \times \text{unit capacity}$$

OUTDOOR TEMPERATURE (°CDB)	-15	-10	-7	-5	0	7	10	15
Correction factor (humidity rate 85% RH)	0.95	0.95	0.89	0.85	0.81	1.0	1.0	1.0

Correction Factor

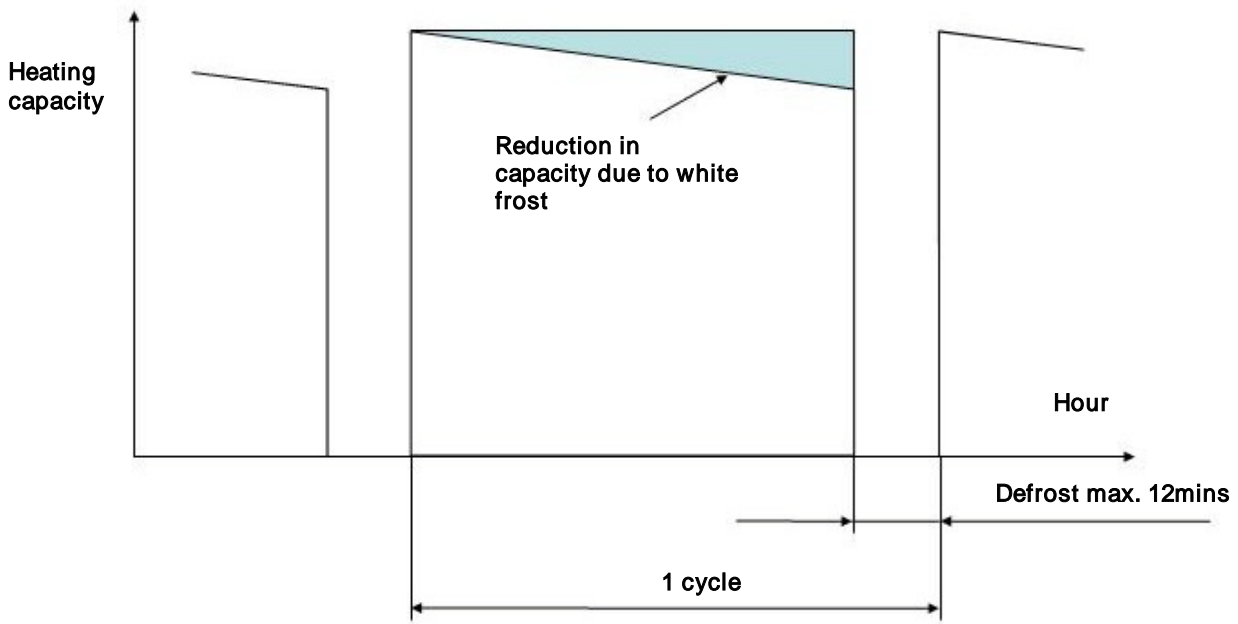

NOTE:

The correction factor is not valid for special conditions such as snowfall or operation in a transitional period.

4 SOUND DATA

4.1. RAC-25WXB

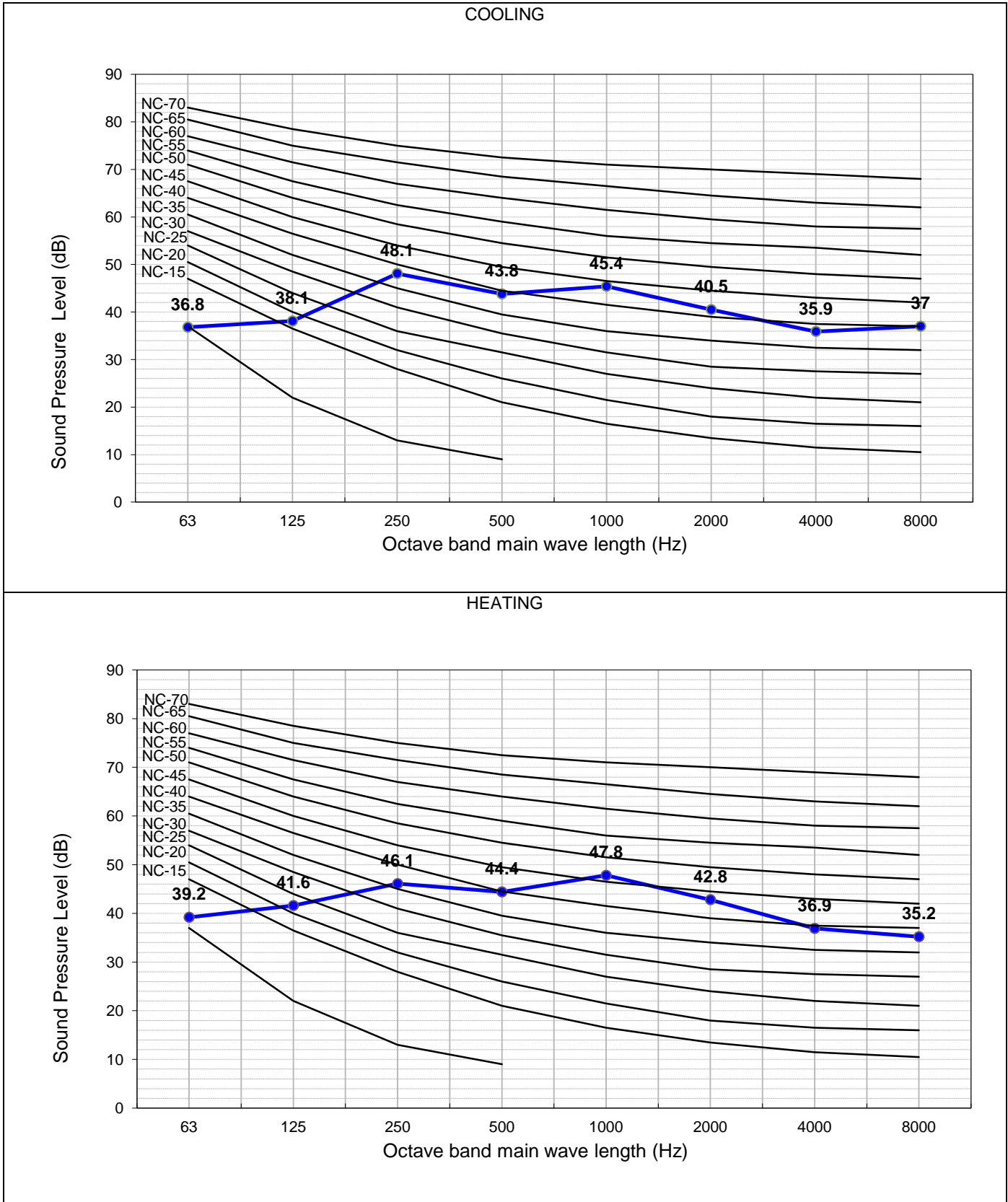

The Sound Pressure Level is based on the following conditions:

- 1 meter from the unit front surface and 1 meter from floor level

The above data was measured in an anechoic chamber. Please take into consideration reflected sound of your specific site

4.2. RAC-35WXB

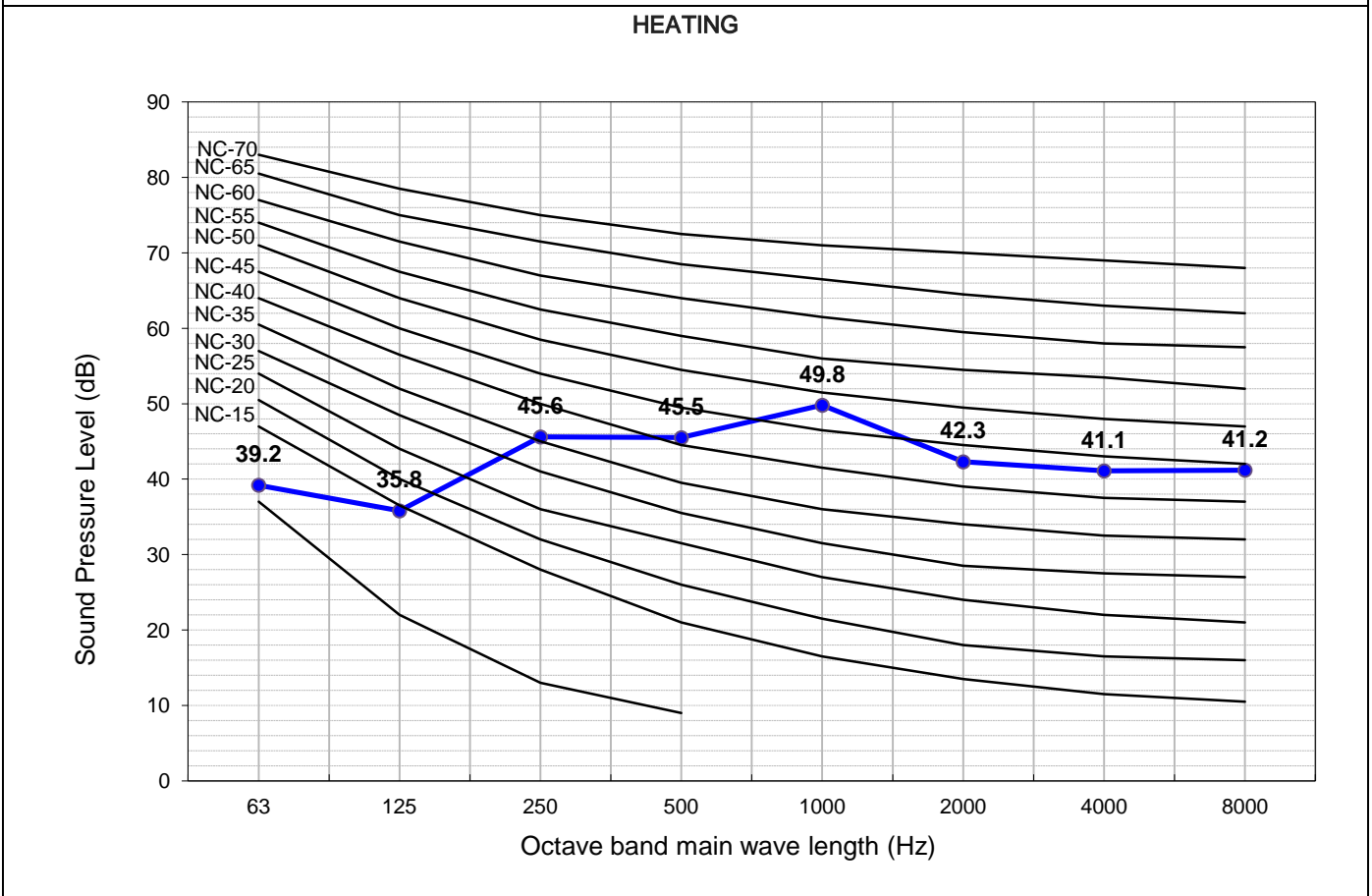
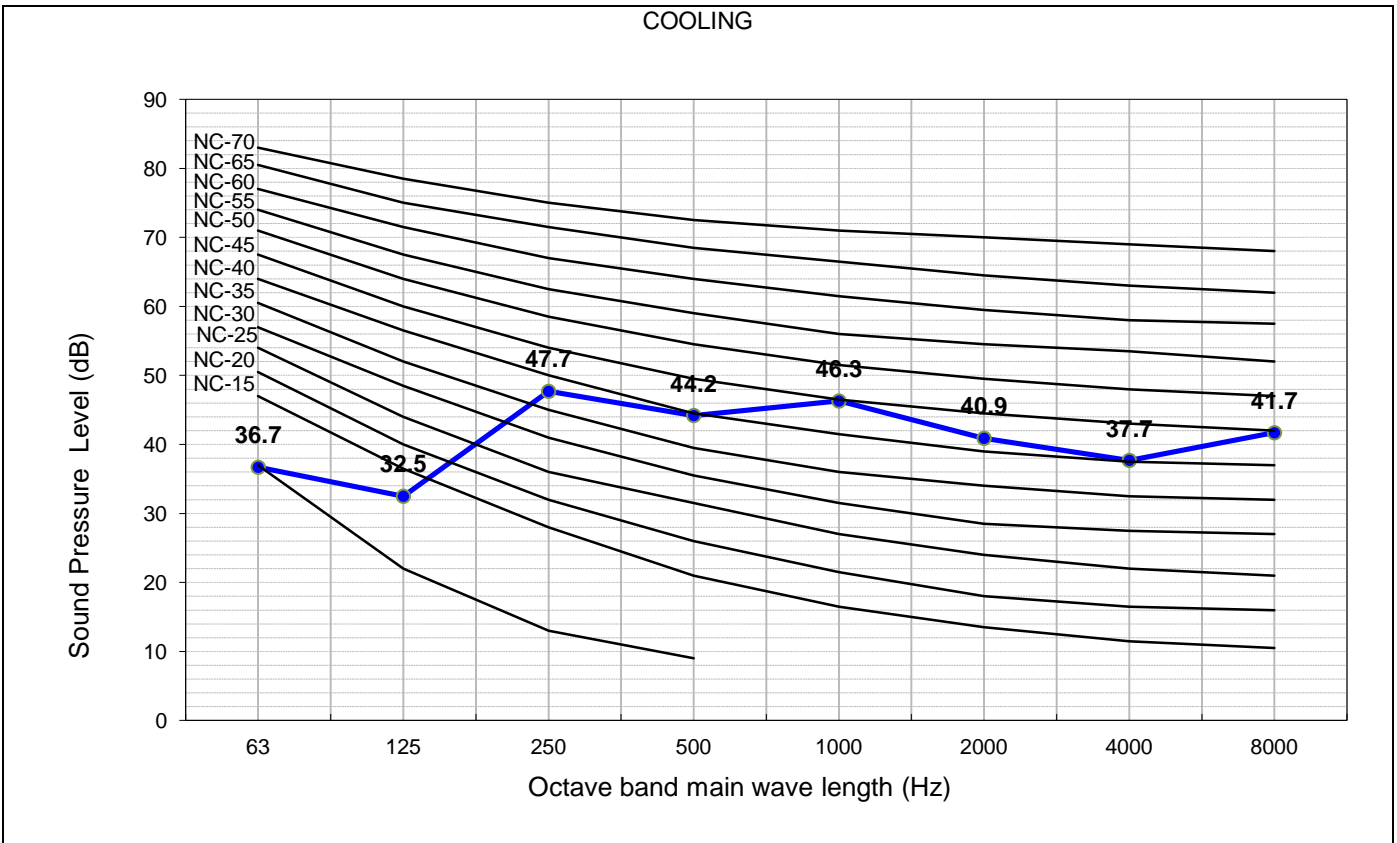

The Sound Pressure Level is based on the following conditions:

- 1 meter from the unit front surface and 1 meter from floor level

The above data was measured in an anechoic chamber. Please take into consideration reflected sound of your specific site

4.3. RAC-50WXB

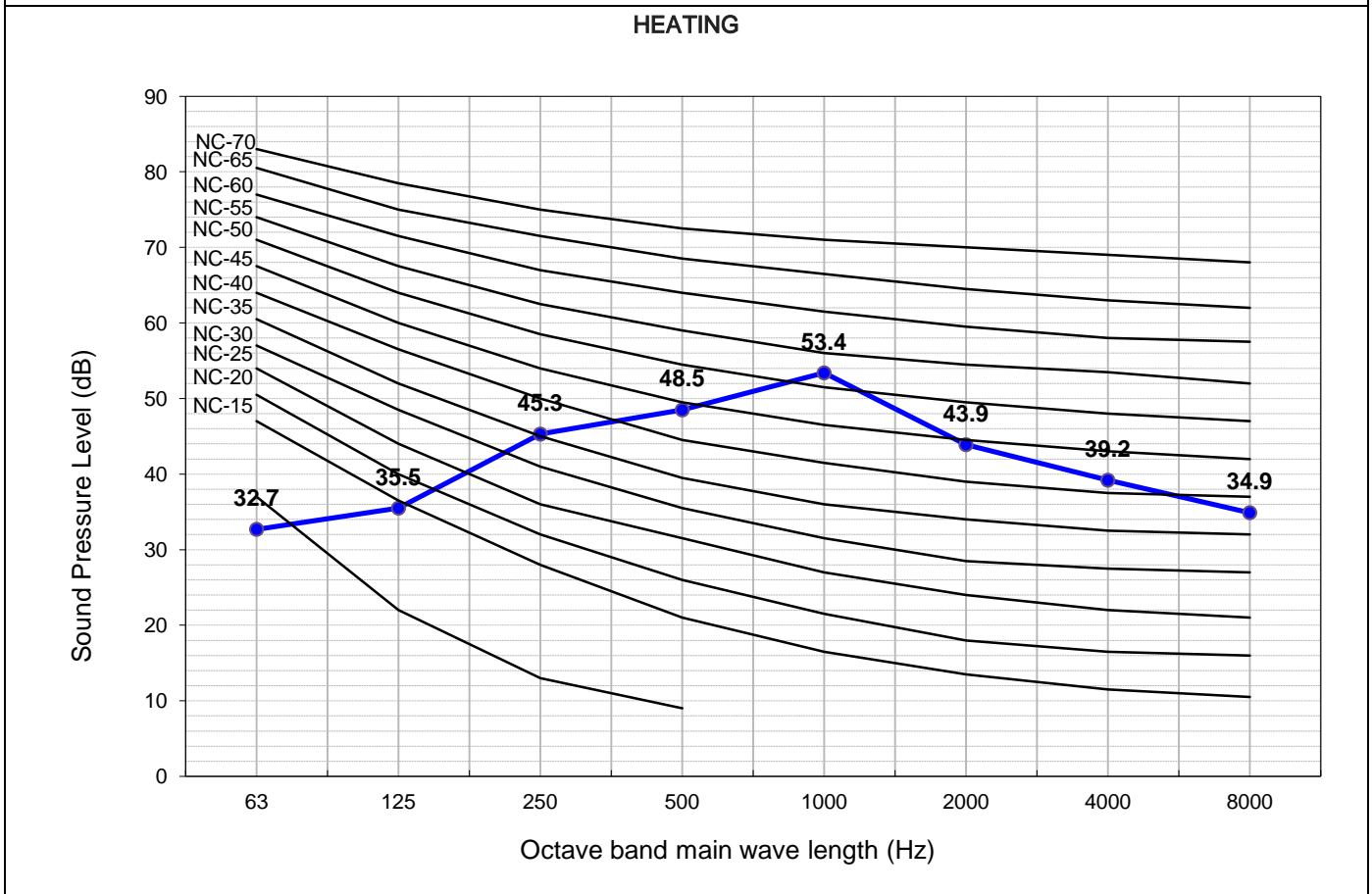
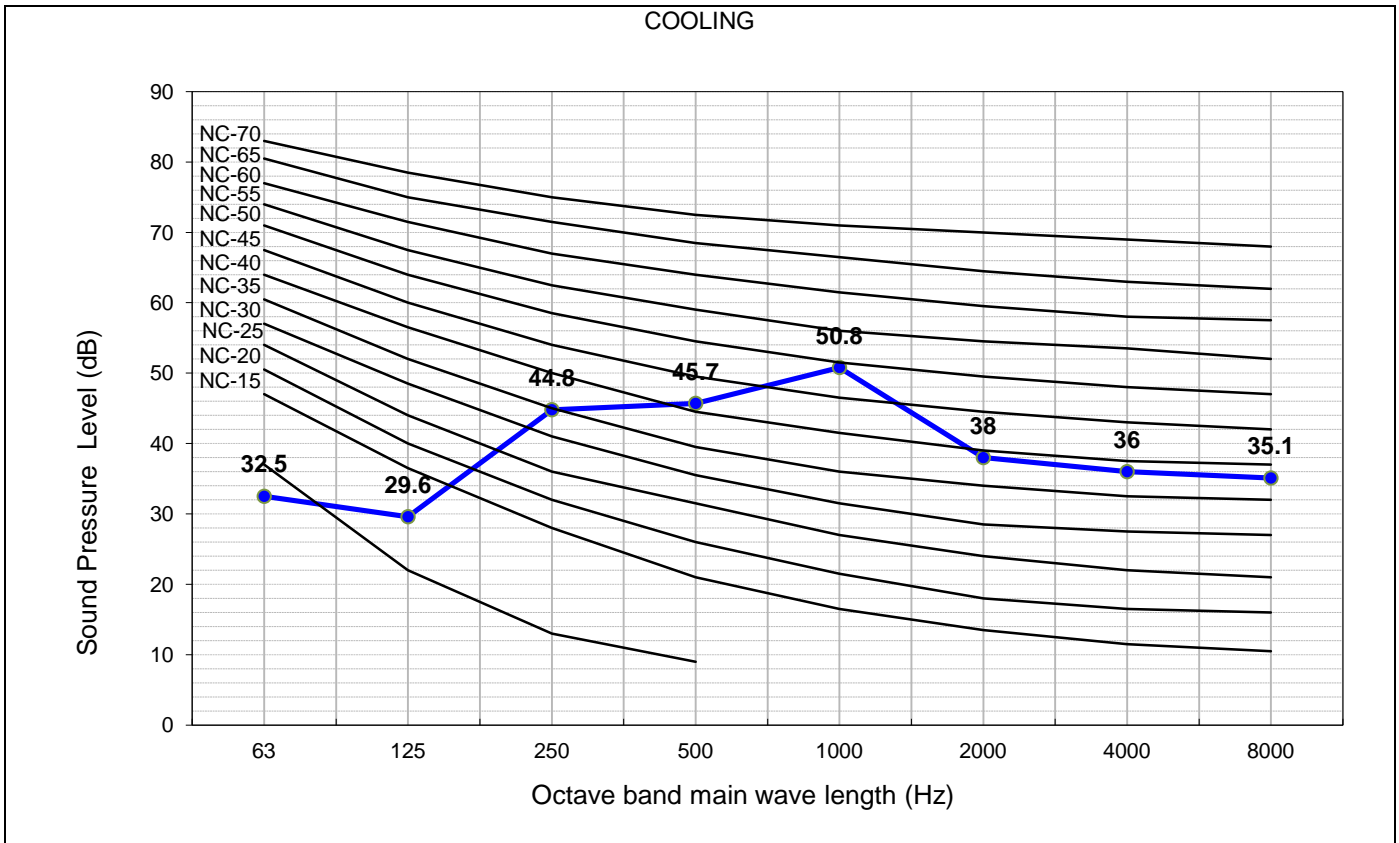

The Sound Pressure Level is based on the following conditions:

- 1 meter from the unit front surface and 1 meter from floor level

The above data was measured in an anechoic chamber. Please take into consideration reflected sound of your specific site

5 WORKING RANGE

5.1. POWER SUPPLY

Working Voltage	207V ~ 253V
Voltage Imbalance	Within a 3% Deviation from Each Voltage at the Main Terminal of Outdoor Unit
Starting Voltage	Higher than 85% of the Rated Voltage

5.2. WORKING RANGE

Applicable models:

RAC-25WXB
RAC-35WXB
RAC-50WXB

The temperature range is indicated in the following table.

Cooling

working range	min (°C)	max (°C)	rated (°C)
outdoor	-10	43	35
indoor	16	43	27

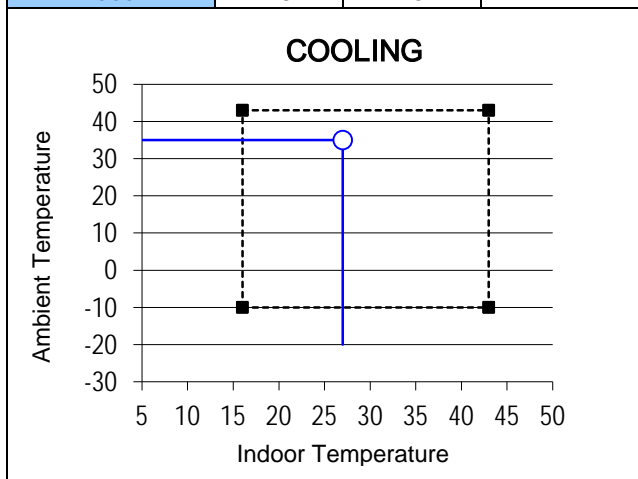

Heating

working range	min (°C)	max (°C)	rated (°C)
outdoor	-15	21	7
indoor	16	26	20

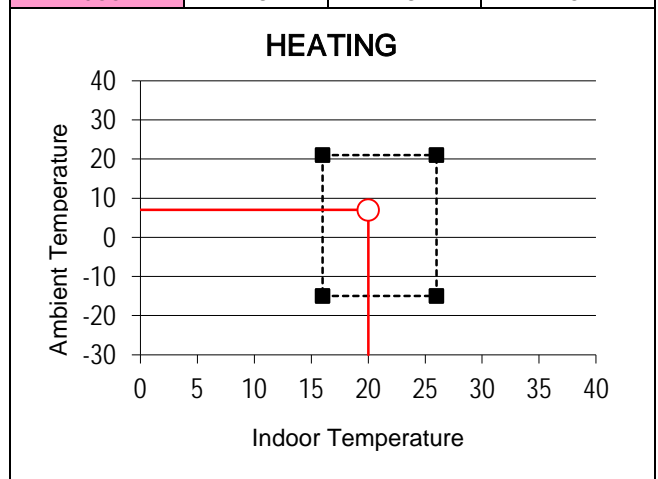

6 ELECTRICAL DATA

6.1. INDOOR UNIT

Model	Unit Main Power		Applicable Current		Indoor Fan Motor	
	VOL, PH, Hz	Fuse Rating (A)	STC	RNC	RNC	IPT
RAK-25RXB	230, 1, 50	3.15	(C) 3.68 (H) 3.85	(C) 5.30 (H) 5.22	0.67	30
RAK-35RXB	230, 1, 50	3.15	(C) 4.72 (H) 4.93	(C) 6.09 (H) 6.96	0.67	30
RAK-50RXB	230, 1, 50	3.15	(C) 7.12 (H) 7.45	(C) 9.13 (H) 11.74	0.67	30

VOL: Rated Unit Power Supply Voltage (V)

Hz: Frequency (Hz)

STC: Starting Current (A)

RNC: Running Current (A)

PH: Phase (ϕ)

IPT: Input (W)

6.2. OUTDOOR UNIT

Model	Unit Main Power				Compressor Motor					
	VOL, PH, Hz	Fuse Rating (A)	Min (V)	Max (V)	Locked Rotor Ampere (A)	STC	Cooling Operation		Heating Operation	
							RNC	IPT	RNC	IPT
RAC-25WXB	230, 1, 50	15	207	253	-	3.85	5.30	545	5.22	700
RAC-35WXB	230, 1, 50	15	207	253	-	4.93	6.96	910	6.09	955
RAC-50WXB	230, 1, 50	25	207	253	-	7.45	11.74	1560	9.13	1560

VOL: Rated Unit Power Supply Voltage (V)

HZ: Frequency (Hz)

STC: Starting Current (A)

RNC: Running Current (A)

PH: Phase (ϕ)

IPT: Input (W)

NOTE:

1. The above compressor data is based on 100% capacity combination of indoor units at the rated operating frequency
2. This data is based on the same conditions as the nominal heating and cooling capacities.
3. The compressor started by an inverter, resulting in extremely low starting current.

7 WIRING DIAGRAM

7.1. RAK-25RXB, RAK-35RXB, RAK-50RXB

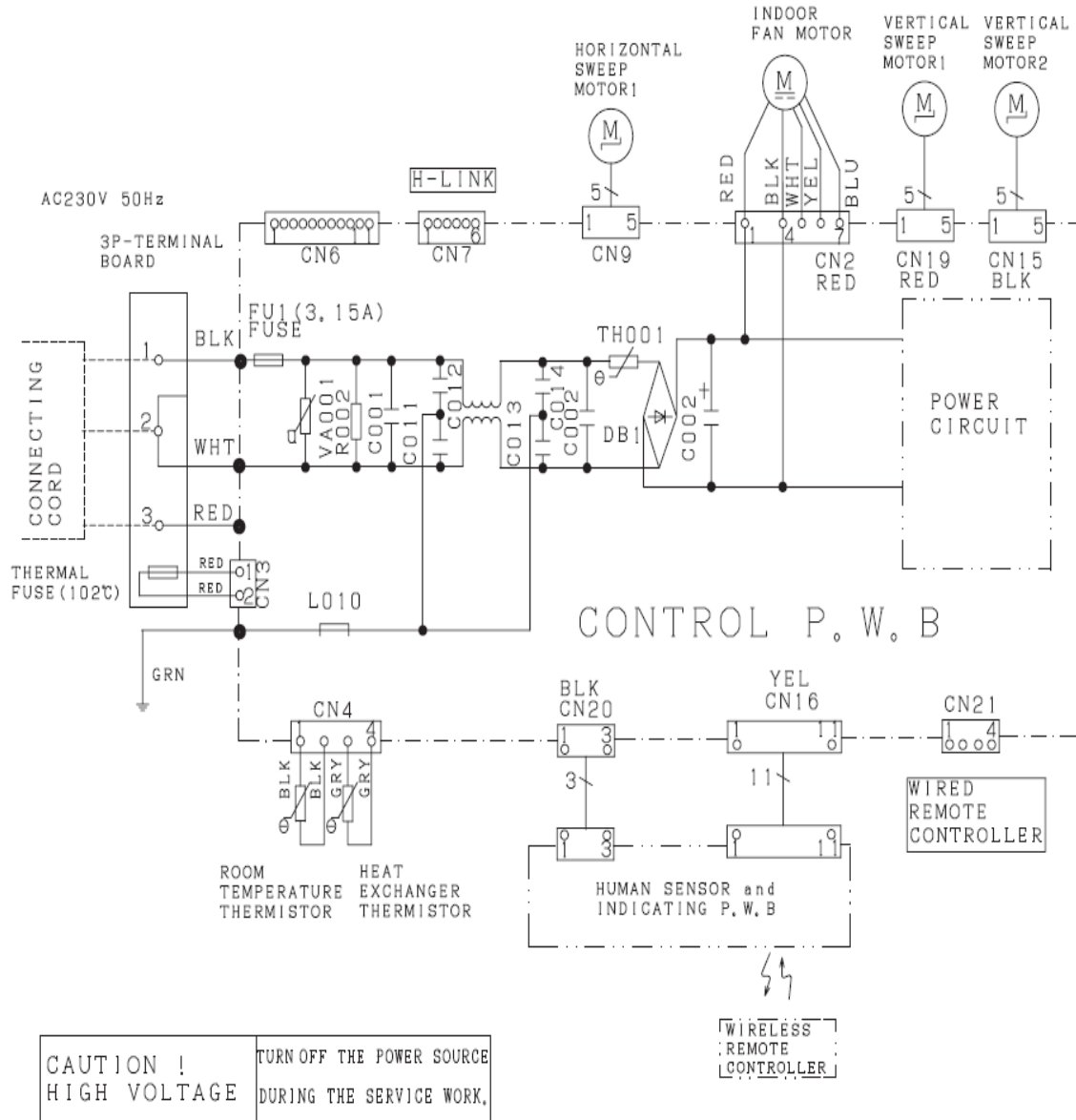

7.2. RAC-25WXB, RAC-35WXB

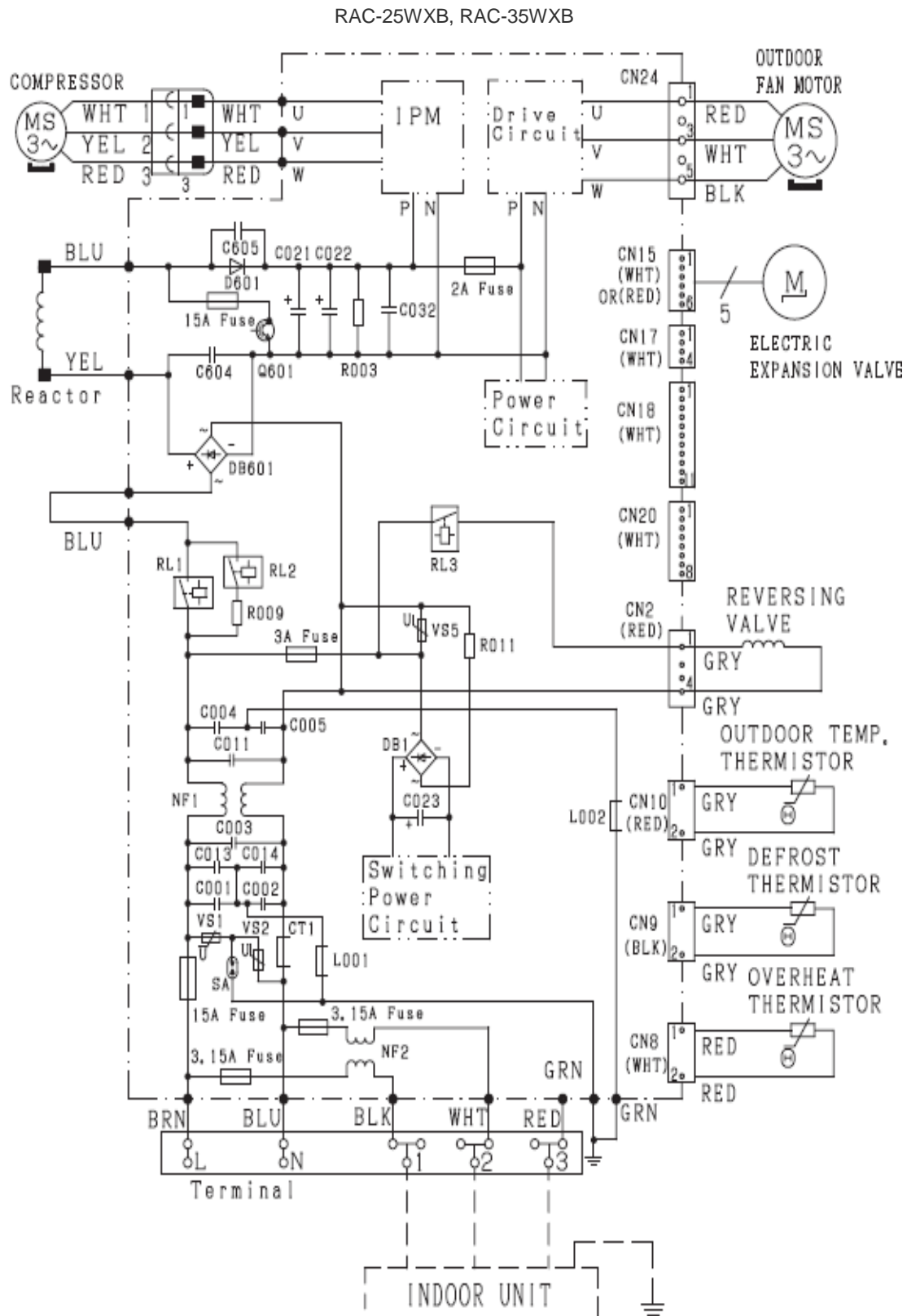

7.3. RAC-50WXB

RAC-50WXB

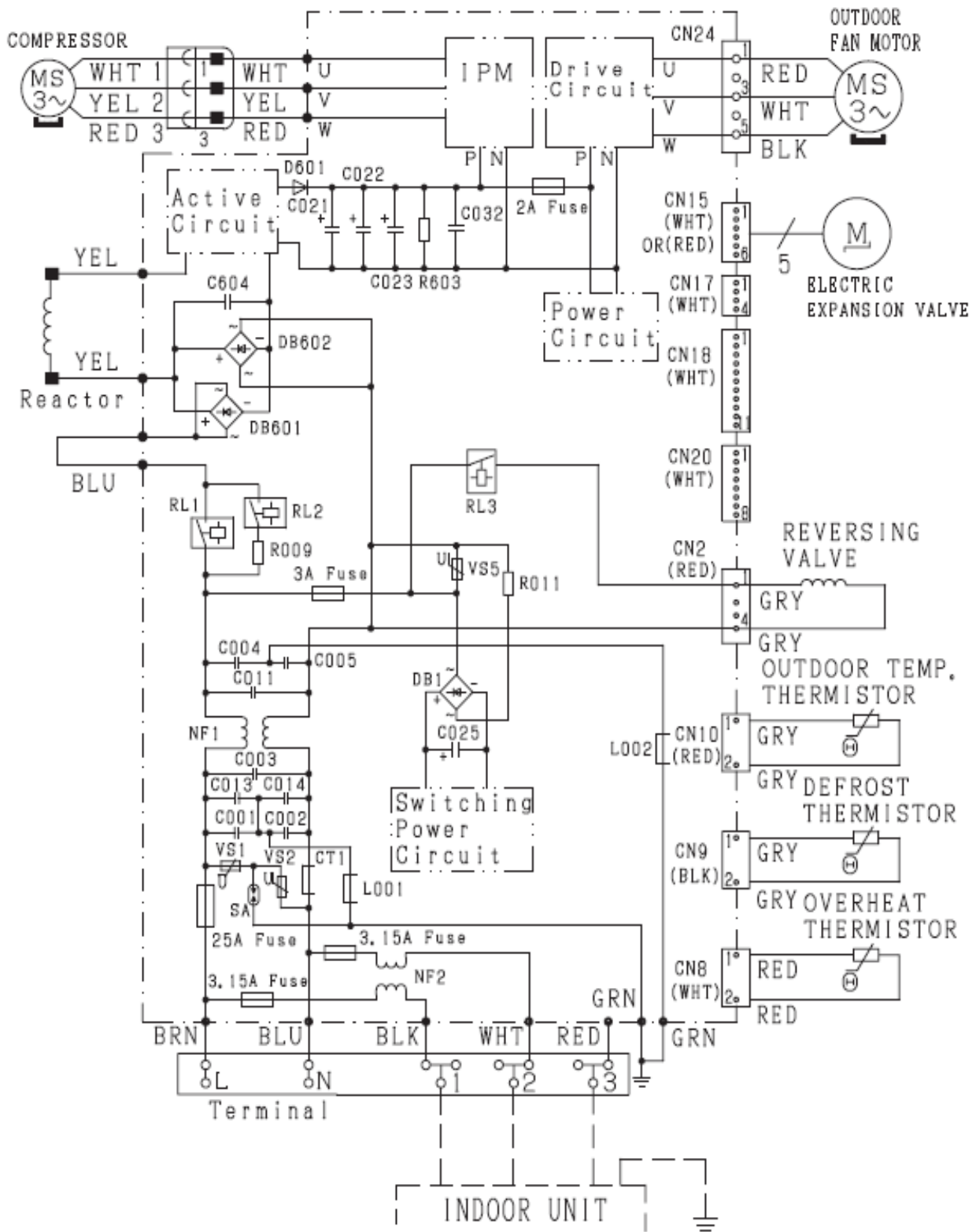

8 REFRIGERANT CYCLE

8.1. WALL TYPE: RAK-25RXB/RAC-25WXB, RAK-35RXB/RAC-35WXB

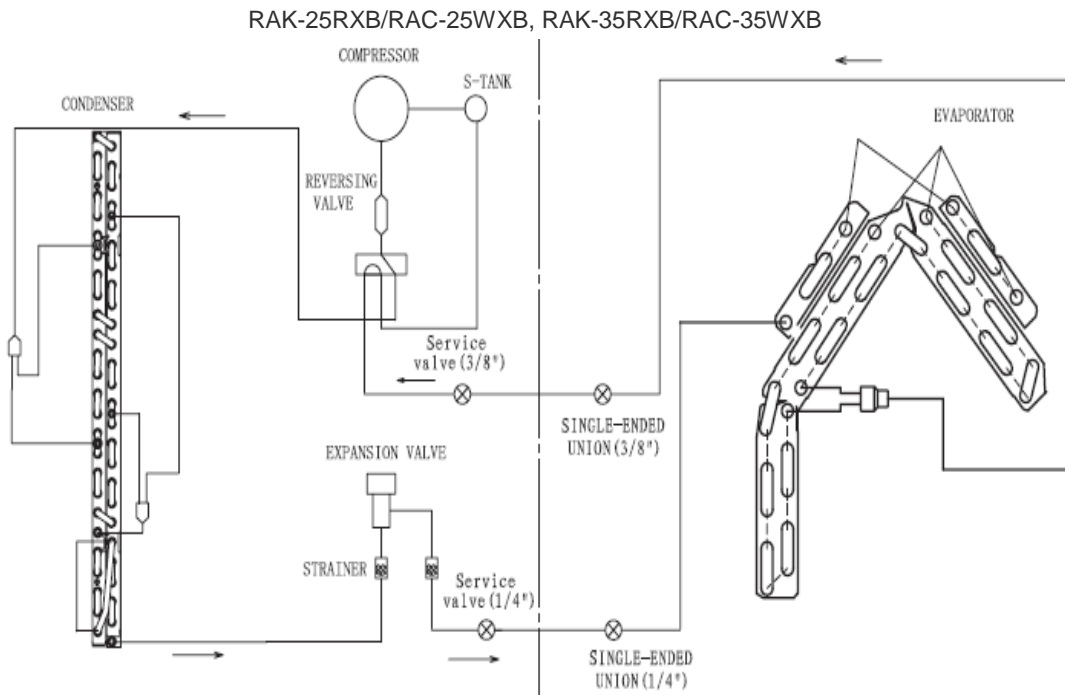



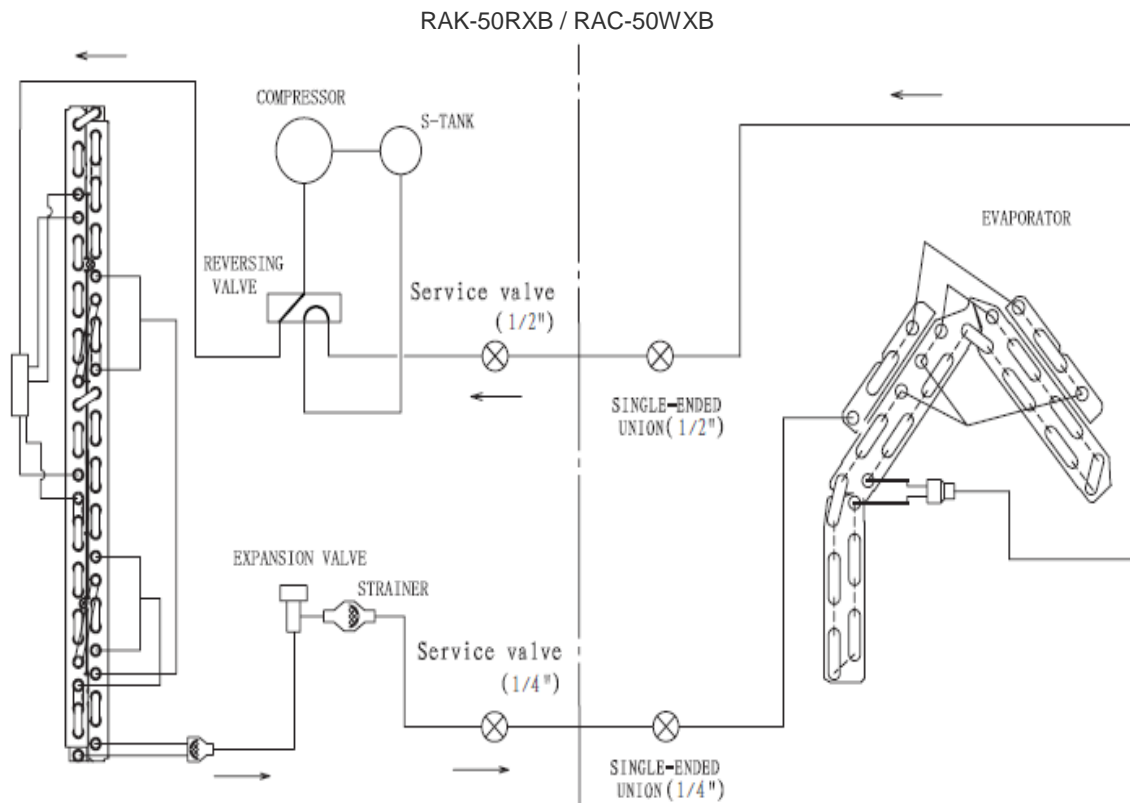





























8.2. WALL TYPE: RAK-50RXB / RAC-50WXB



9 CONTROL AND FUNCTION

9.1. WIRELESS REMOTE CONTROL FUNCTION

BUTTONS	FUNCTION
	MODE Selector Use this button to select the operating mode. Every time you press this button, the mode will change from  (AUTO) →  (HEAT) →  (DEHUMIDIFY) →  (COOL) and →  (FAN) cyclically.
	FAN SPEED Selector Button This determines the fan speed. Every time you press this button, the airflow rate will change from  (AUTO) →  (HIGH) →  (MED) →  (LOW) →  (SILENT) (This button allows selection of optimal or preferred fan speed for each operation mode).
	START/STOP button Press this button to start operation. Press it again to stop operation.
	ECO button Use this button to set the ECO mode.
	POWERFUL button Use this button to set the POWERFUL mode.
	SILENT button Use this button to set the SILENT mode.
	INFO button 1) Press this button to display temperature for 10 seconds. 2) Press this button to check monthly power consumption. 3) Press this button to receive the current calendar and clock.
	ECO SLEEP TIMER button Use this button to set the ECO sleep timer.
	AUTO SWING (Vertical) button Controls the angle of the horizontal air deflector.
	AUTO SWING (Horizontal) button Controls the angle of the vertical air deflector.
	LEAVE HOME button Prevent the room temperature from falling too much by setting temperature 10°C~16°C when no one is at home.
	ONE TOUCH CLEAN button Drying indoor heat exchanger after cooling operation to prevent mildew.
WEEKLY TIMER buttons	
	ON/OFF TIMER button The device will turn on (off) and off (on) at the designated time.
	TIME button Press the button to set starting time of the program
	OK button Press the button to save the program. The button shall be pressed everytime after finishing a program setting.
	DELETE button 1) Press the button to delete the selected program. 2) Press the button for about 10 seconds by directing the remote controller towards the indoor unit while Mode A or B display blinks, programs for Mode A or B will be deleted both from the indoor unit and the remote controller after the beep sound from the indoor unit.
	DAY button Select the desired day of the week.
	PROGRAM NO. Button Press this button to select a program number.
	CANCEL 1) Press the button to cancel the current setting process on the screen. 2) Press the button by directing the remote controller towards the indoor unit, then weekly timer setting will be canceled from indoor unit after the beep sound from the indoor unit. The program setting remains in the remote controller.
	SEND button Press the button for about 3 seconds by directing the remote controller towards the indoor unit after finishing the program setting. Timer lamp on the indoor unit will blink rapidly and after the beep sound from indoor unit, TIMER lamp will light up.
	CLOCK button Press the button to set calendar and clock.
	WEEKLY TIMER MODE button 1) Select Mode A or Mode B. 2 modes can be set and stored as a weekly timer. 2) By pressing the button longer than 3 seconds, program setting screen will appear.



RAR-6N1

9.2. AUTO CHANGEOVER

COOLING/HEATING mode is decided by the room temperature.

- A. COOLING/HEATING mode is decided during the **initial startup** of Automatic Operation
 Initial startup of Automatic Operation means the following either condition:
- Unit start up in Automatic Operation
 - Automatic Operation mode is pressed while the unit is running in manual mode

Startup room temperature	COOL / HEAT
>= Remote controller setting temperature	Unit runs in COOLING mode
< Remote controller setting temperature	Unit runs in HEATING mode

- B. COOLING/HEATING mode is decided in **intervals after the initial startup** of Automatic Operation (also known as Auto Changeover function)

Intervals	Duration
1 st interval	10 minutes
2 nd interval	15 minutes
Subsequent interval	Every 55 minutes

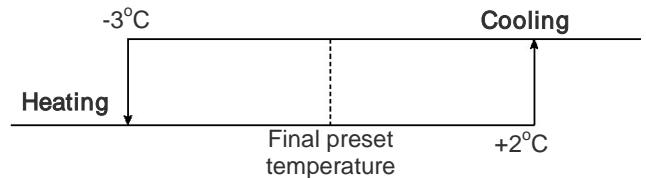

9.3. SHIFT VALUE

1. Press and hold \odot (START/STOP) button and \odot (ON) button.
2. Press RESET [RESET] button on the same time. Release RESET [RESET] button only, then release \odot (START/STOP) and \odot (ON) button once Screen 1 appears.

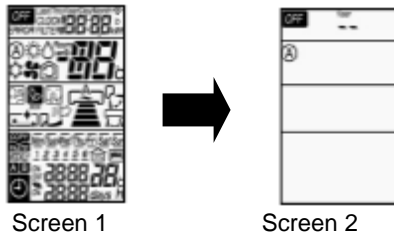

4. Press \odot (START/STOP) and Screen 4 appear.

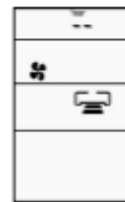

5. Select FAN (FAN SPEED) button to choose Heating Shift or Cooling Shift Mode (Screen 5).

By setting fan speed to HIGH H or MED M , it will go to Cooling Shift mode.
 By setting fan speed to LOW L or SILENT S , it will go to Heating Shift mode.

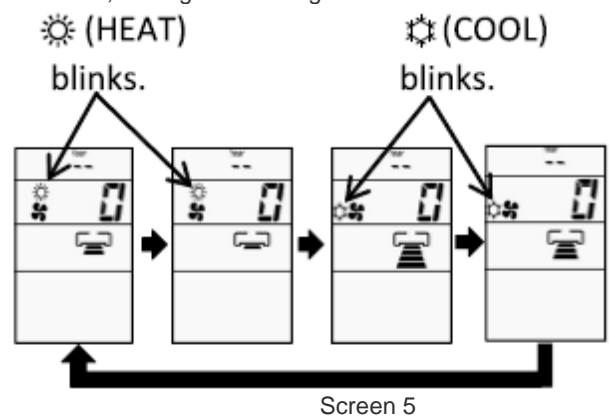
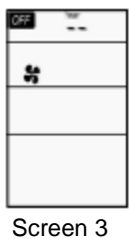

3. Press the MODE (MODE) button to display FAN fan mode (Screen 3).

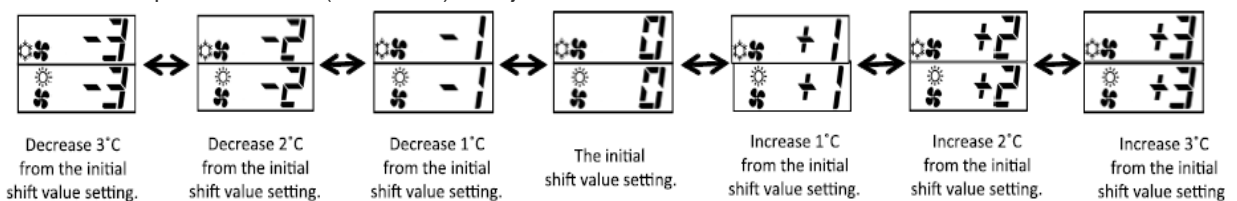

6. Press the Temperature button (V or ^) to adjust the shift value.









NOTE:

1. There are total of 7 shift values ranging from -3 to 3.
2. The displayed shift value,  (HEAT) and  (COOL) symbol on the remote controller display will be disappear after 10 seconds
3. The changed shift value will remain unchanged after turned off the power.
4. If "0" is displayed on the remote controller display, it indicates the shift value is now at the initial setting.

9.4. OPERATION LOCK

1. HEATING MODE

- a) Press and hold  (ECO) and  (POWERFUL) buttons, press  (RESET) button on the same time. Release  (RESET) button only when Screen 1 appear, then release  (ECO) button and  (POWERFUL) button.



Screen 1



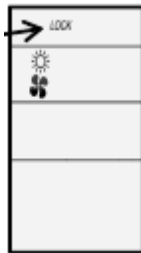

- b) Wait until only Screen 2 appear.





Screen 2

- c) The heating mode operation is locked.
- d) To unlock HEATING mode, repeat step (a). After all operations mode symbols displayed for 10 seconds, the operation mode symbol before cancellation will be display. The heating mode operation is unlocked.

2. COOLING AND DEHUMIDIFYING MODE

- a) Press and hold  (ECO) and  (SILENT) buttons for at least 5 seconds when the remote controller is OFF.
- b) Wait until only  and  displayed on the screen. The cooling and dehumidifying modes operation is locked.
- c) To unlock HEATING mode, repeat step (a). After all operations mode symbols displayed for 10 seconds, the operation mode symbol before cancellation will be display. The cooling and dehumidifying mode operation is unlocked.

9.5. SETTING THE PREVENTION OF MUTUAL INTERFERENCE

1. Please ensure the other indoor unit is OFF.
2. Press  (PROGRAM NO.) button,  (ON TIMER) button and  (RESET) button simultaneously. The remote controller will display Screen 1 and followed by Screen 2. The indoor unit beeps to indicate that it has just received the signal from remote controller.



Screen 1



Screen 2







NOTE:

1. If indoor unit still not receive the correct signal from the correct remote controller, setting shall be made again. By setting again for the 2nd time, the signal address will change from B to A, then repeat again for the 3rd time.

9.6. INTERMITTENT FAN SPEED SETTING

The intermittent fan control during thermo off in Heating Mode can be changed by the remote controller.
(This procedure should be done only by service personnel.)
It is possible to select from 3 patterns.

PROCEDURE

- Press  [START/STOP] button,  [Mon-Sun] button and press  [RESET] button simultaneously. Release  [RESET] button only and make sure that all marks on the remote controller display are indicated, then release  [START/STOP] button and  [Mon-Sun] button. Remote controller now enters "Intermittent Fan Control Change Mode".

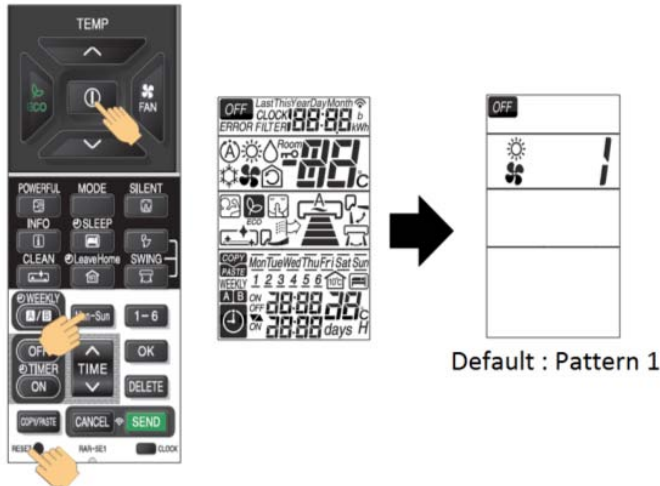

- Press [ROOM TEMPERATURE setting] [\wedge (UP)]/[\vee (DOWN)] buttons.
(The intermittent pattern changed with indoor unit beep sound.)

Transmission sign lights up with beep from indoor unit simultaneously.

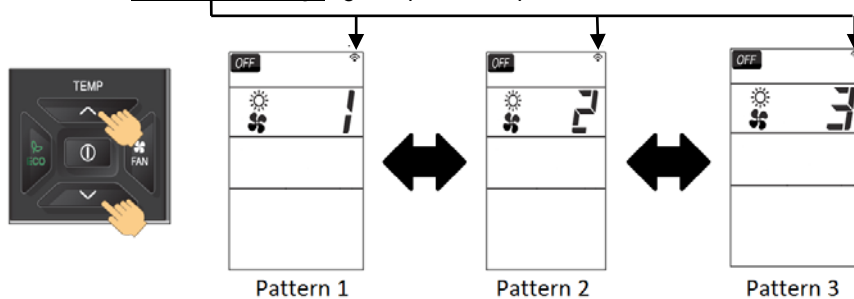

	Pattern 1	Pattern 2	Pattern 3
Single Model	Continuous	30sec ON / 210sec OFF repeatedly	50sec ON / 190sec OFF repeatedly
Multi Model	30sec ON / 210sec OFF repeatedly	50sec ON / 190sec OFF repeatedly	Continuous



NOTE :

- (1) The indication of the selected intermittent pattern will disappear after 10 seconds.
- (2) The selected intermittent pattern will remain unchanged after the unit is turned off.

9.7. FAN SPEED SETTING IN THERMO OFF IN COOLING

The fan speed in Cooling Mode during thermo off can be changed by the remote controller.
 (This procedure shall be implemented strictly by service personnel only.)
 It is possible to return it to the default setting.

PROCEDURE

Press  [POWERFUL] button and  [TIME ^ (UP)] button simultaneously for about 5 seconds when the remote controller is OFF.

Transmission sign lights up with beep from indoor unit simultaneously.

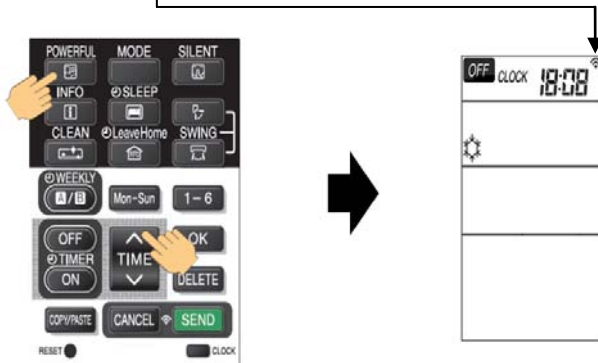



- Beep sound pattern :
- 1) Default setting : Short beep
 - 2) Changed setting : Double beep

	Fan speed during thermo off
Default Setting	Ultra low
Changed Setting	Set fan speed (When auto fan speed is set, the fan speed is low)

NOTE :

- (1) The selected fan speed will remain unchanged after the unit is turned off.
- (2) If Timer reservation has been set, it will be canceled.
- (3) During time setting and timer setting, this operation cannot be set.

9.8. ERROR CODE INFORMATION

1. In case failure occurs to the air conditioner, by pressing  (INFO) button, an error code will be displayed.
2. Direct the remote controller towards the receiver of indoor unit (within 2 meters in from of indoor unit) and press  (INFO) button.
3. Wait for 2 seconds for signal transmission and the error code will be displayed.

	TIMER LAMP BLINKING	LED301 BLINKING	CODE	MEANING
INDOOR	-	-	000 00	Normal
	1 time	-	001 00	Refrigerant cycle fault
	2 times	-	-	Outdoor unit is under forced operation
	3 times	9 times	003 00	Communication error between indoor and outdoor units
	9 times	-	009 00	Indoor thermistor
	10 times	-	010 00	Abnormal rotating numbers
	13 times	-	013 00	IC401 data reading error
OUTDOOR	4 times	2 times	002 01	Peak current cut
	4 times	3 times	003 01	Compressor abnormal low speed rotation
	4 times	4 times	004 01	Compressor switching failure
	4 times	5 times	005 01	Overload lower limit cut
	4 times	6 times	006 01	OH thermistor temperature rise
	4 times	7 times	007 01	Abnormal outdoor thermistor
	4 times	8 times	008 01	Acceleration defective
	4 times	9 times	009 01	Communication error
	4 times	10 times	010 01	Abnormal power source
	4 times	11 times	011 01	Fan stop for strong wind
	4 times	12 times	012 01	Fan motor fault
	4 times	13 times	013 01	EEPROM reading error
	4 times	14 times	014 01	Active converter defective
4 times	15 times	015 01	Abnormal PWB circuit	

	TIMER LAMP BLINKING	LD301 Lit LD302 BLINKING	CODE	MEANING
OUTDOOR	4 times	1 times	071 01	Overheat thermostat
	4 times	2 times	072 01	Defrost thermostat
	4 times	3 times	073 01	Outdoor temperature thermostat
	4 times	4 times	074 01	Narrow pipe thermostat (indoor 1)
	4 times	5 times	075 01	Wide pipe thermostat (indoor 1)
	4 times	6 times	076 01	Narrow pipe thermostat (indoor 2)
	4 times	7 times	077 01	Wide pipe thermostat (indoor 2)
	4 times	8 times	078 01	Narrow pipe thermostat (indoor 3)
	4 times	9 times	079 01	Wide pipe thermostat (indoor 3)
	4 times	10 times	080 01	Narrow pipe thermostat (indoor 4)
	4 times	11 times	081 01	Wide pipe thermostat (indoor 4)
	4 times	12 times	082 01	Narrow pipe thermostat (indoor 5)
	4 times	13 times	083 01	Wide pipe thermostat (indoor 5)

9.9. ADDITIONAL FUNCTION VIA DIP-SWITCH SETTINGS

A new DIP Switch is available on the PWBs of the indoor unit that provide additional functions via the settings on the switches.

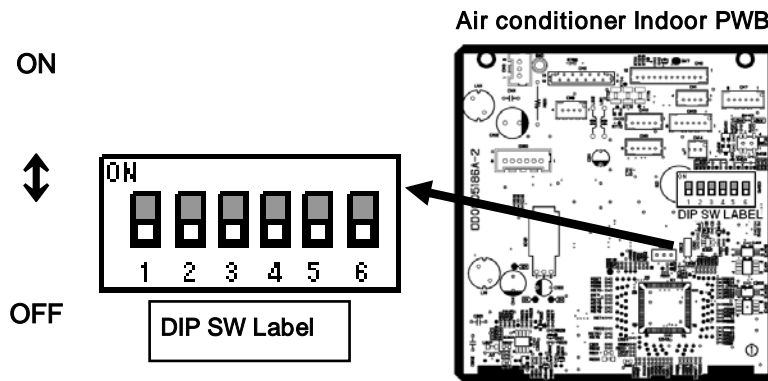

Pin No.	Function	Switch Position / Setting					
		OFF	Enable	ON	Disable		
1	AUTO RESTART function	OFF	Enable	ON	Disable		
2	DRY CONTACT function	OFF	Disable	ON	Enable		
3	DRY CONTACT Logic Select	OFF	HI Input Active	ON	LO Input Active		
4	HEATING / COOLING ONLY MODE SELECT	OFF	NORMAL (HEAT AND COOL)	OFF	HEATING ONLY	ON	COOLING ONLY
5		OFF		ON		OFF	
6	REMOCON ID SELECT ❖1	OFF	SELECT ID A	ON	SELECT ID B		

NOTE:

- ❖1 The setting of pin no. 6 is disabled for this model. Please refer to **9.5 SETTING THE PREVENTION OF MUTUAL INTERFERENCE**.

9.9.1. AUTO RESTART FUNCTION

The AUTO RESTART function can be enabled or disabled by setting Pin No. 1 on the DIP SWITCH above to the ON or OFF position accordingly.





















9.9.2. HEATING/COOLING ONLY MODEL SELECTION

When this function is enabled, the operation mode could be locked to either Heating Only (Heating or Fan) or Cooling Only (Cooling, Fan or Dehumidifying) by setting the Pin No. 4 and 5 accordingly.





LOCKED MODE	REMARKS
HEATING ONLY	Unit will not enter into Cooling mode although cooling mode is selected using the remote controller.
COOLING ONLY	Unit will not enter into Heating mode although heating mode is selected using the remote controller.

10 OPTION LIST

10.1. WIRED REMOTE CONTROL – SPX-RCDB



 <p>RAR-5G2 (SPX-RCDB)</p>	BUTTONS	FUNCTION
		MODE Selector Use this button to select the operating mode. Every time you press this button, the mode will change from  (AUTO) →  (HEAT) →  (DEHUMIDIFY) →  (COOL) and →  (FAN) cyclically.
		FAN SPEED Selector Button This determines the fan speed. Every time you press this button, the airflow rate will change from  (AUTO) →  (HIGH) →  (MED) →  (LOW) →  (SILENT) (This button allows selection of optimal or preferred fan speed for each operation mode).
		ON/OFF button Press this button to start operation. Press it again to stop operation.
		SLEEP button Use this button to set the SLEEP timer.
		SET button Timer setting reservation.
		OFF button Select the turn OFF timer.
		ON button Select the turn ON timer.
		CANCEL button Cancel timer reservation.
		AUTO SWING (Vertical) button Controls the angle of the horizontal air deflector.
	ROOM TEMPERATURE setting button Value will change quicke when keep pressing.	

10.1.1. SHIFT VALUE

1. Press and hold  (ON/OFF) button and  (ON TIMER) button at the same time while giving a single press on the RESET button until remote controller now enter 'Shift value change mode'.
2. Press  (ON/OFF) button so that the display indicates  (FAN) speed.
3. Select  (FAN SPEED) button to choose Heating Shift or Cooling Shift Mode.

By setting fan speed to HIGH  or MED  , it will go to Cooling Shift mode.

By setting fan speed to LOW  or SILENT  , it will go to Heating Shift mode.



4. Press  (ROOM TEMPERATURE) button to change the shift value (-3°C ~ 0 ~ 3°C).
5. Press  (ON/OFF) button to end 'Shift value setting mode'.





NOTE:

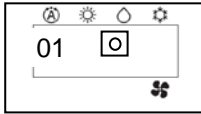
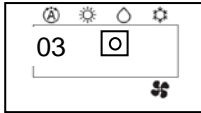
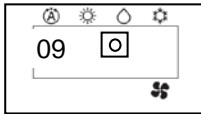

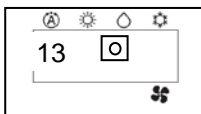
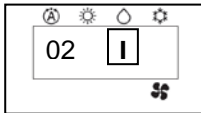
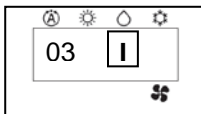
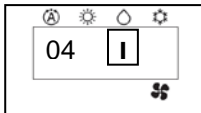
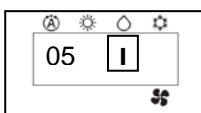

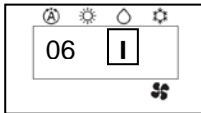
1. There are total of 7 shift values ranging from -3 to 3.
2. The changed shift value will remain unchanged after turned off the power.

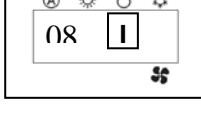
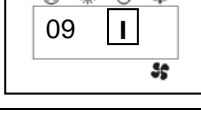
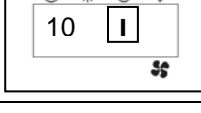
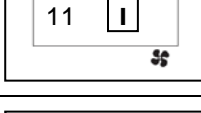
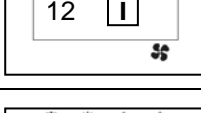
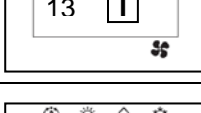
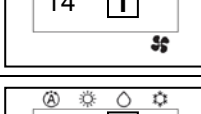
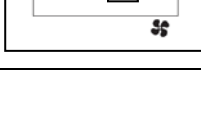
10.1.2. ERROR CODE INFORMATION

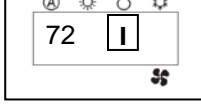
- In case failure occurs to the air conditioner, the error code will constantly appear on the wired remote controller display.

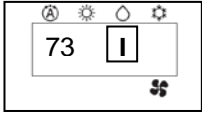
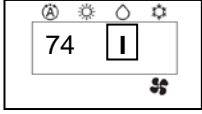
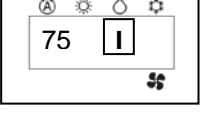
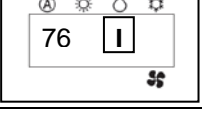
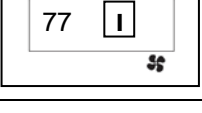
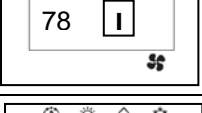
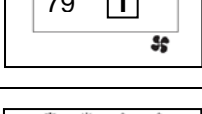
	TIMER LAMP BLINKING	LD301 BLINKING	CODE	MEANING
INDOOR	-	-	-	Normal
	1 time	-		Refrigerant cycle fault
	2 times	-	-	Outdoor unit is under forced operation
	3 times	9 times		Communication error between indoor and outdoor units
	9 times	-		Indoor thermistor
	10 times	-		Abnormal rotating numbers
	13 times	-		IC401 data reading error
OUTDOOR	4 times	2 times		Peak current cut
	4 times	3 times		Compressor abnormal low speed rotation
	4 times	4 times		Compressor switching failure
	4 times	5 times		Overload lower limit cut

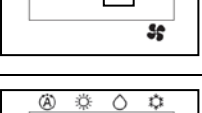
	TIMER LAMP BLINKING	LD301 BLINKING	CODE	MEANING
OUTDOOR	4 times	6 times		OH thermistor temperature rise
	4 times	7 times		Abnormal outdoor thermistor
	4 times	8 times		Accelaration defective
	4 times	9 times		Communication error
	4 times	10 times		Abnormal power source
	4 times	11 times		Fan stop for strong wind
	4 times	12 times		Fan motor fault
	4 times	13 times		EEPROM reading error
	4 times	14 times		Active converter defective
	4 times	15 times		Abnormal PWB circuit
		LD301 Lit LD302 BLINKING		
	4 times	1 times		Overheat thermostat
	4 times	2 times		Defrost thermostat

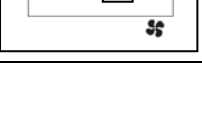
	TIMER LAMP BLINKING	LD301 Lit LD302 BLINKING	CODE	MEANING
OUTDOOR	4 times	3 times		Outdoor temperature thermostat
	4 times	4 times		Narrow pipe thermostat (indoor 1)
	4 times	5 times		Wide pipe thermostat (indoor 1)
	4 times	6 times		Narrow pipe thermostat (indoor 2)
	4 times	7 times		Wide pipe thermostat (indoor 2)
	4 times	8 times		Narrow pipe thermostat (indoor 3)
	4 times	9 times		Wide pipe thermostat (indoor 3)
	4 times	10 times		Narrow pipe thermostat (indoor 4)
	4 times	11 times		Wide pipe thermostat (indoor 4)
	4 times	12 times		Narrow pipe thermostat (indoor 5)
	4 times	13 times		Wide pipe thermostat (indoor 5)

10.2. H-LINK ADAPTOR – PSC 6RAD

10.2.1. SAFETY SUMMARY

DANGER:

- DO NOT pour water into the remote control switch (hereafter called “controller”). This product is equipped with electrical parts. This will cause serious electrical shock.

WARNING:

- DO NOT perform installation work and electrical wiring connection by yourself. Contact your distributor or dealer of HITACHI and ask then for installation work and electrical wiring by service person. The specified cable should be used to connect (i) room air conditioner and adaptor, and (ii) controller and adaptor.



CAUTION:



- DO NOT install the indoor unit, outdoor unit, controller and cable as such places as:
 - where there is oil vapor and dispersion of oil
 - where there is sulfuric environment (near the hot springs)
 - where there is a flammable gas
 - where there is salty environment (near the sea)
- DO NOT install the indoor unit, outdoor unit, controller and cable within approximately 3 meters from strong electromagnetic wave radiators, such as medical equipment. In case that the controller is installed in a place where there is electromagnetic wave direct-radiation, shield the controller and cables by covering with the steel box and running the cable through the metal conduit tube.
- In case that there is electric noise at the power source for the indoor unit, provide a noise filter.

10.2.2. INSTALLATION WORK

■ Before installation

Check the contents and the number of the accessories in the packing.

Adaptor	 <p>With two 1.8m cables</p>
1 piece of cover for hiding the covering	 <p>Attached 2 sided tapes</p>
Two-sided tape for attaching to Adaptor	 <p>110x40x3mm</p>

2 connectors for H-Link connection		
2 tapping screws for attaching to wall		φ3.0 x 10mm
2 screws for attaching to wooden wall		φ3.1 x 16mm

- 1) RAC adaptor can be installed to the wall as well as on the air conditioner itself
- 2) Install RAC adaptor in the vertical surface as shown below.

Upper side

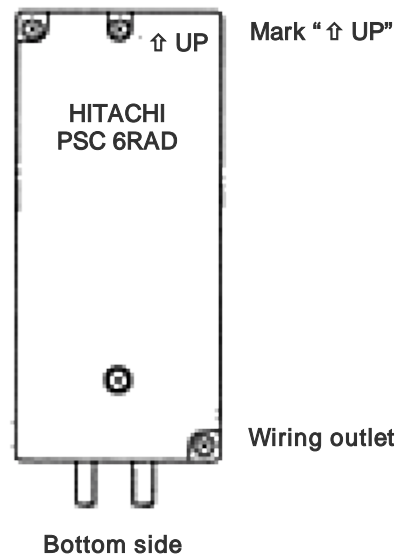

- 3) Installation procedure
 - a) When installing to the wall.
 - i) Fix the adaptor with 2 screws. Tapping screw is for metal surface, and other screw is for wooden surface.

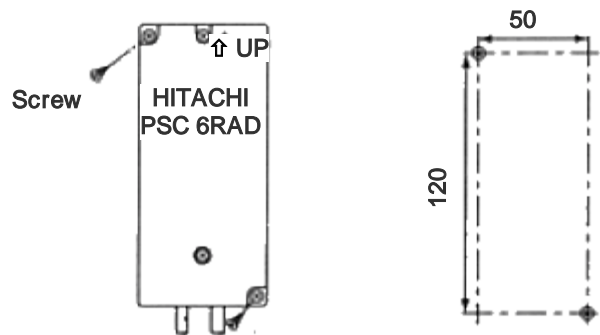

- ii) When using the cover
 - i) It can be installed at the right and left side of room air conditioner. Fix the cover and RAC adaptor with the two-sided tape (accessory).

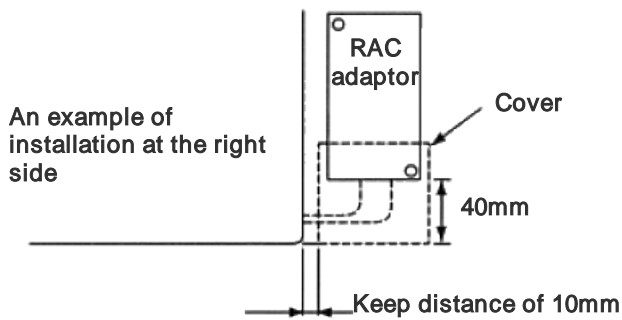

An example of installation at the right side

- b) When installing on the room air-conditioner
 - In case that it cannot be installed to the wall due to the space or material problem, install the RAC adaptor with the two-sided tape (accessory) on the room air-conditioner.
 - i) Confirm if the piping cover of the unit can be removed when performing the service maintenance, and then fix the RAC adaptor in the side of room air-conditioner with two-sided tape. (Available at the right as well as left side)
 - ii) Clean the surface to be installed with a dry cloth.

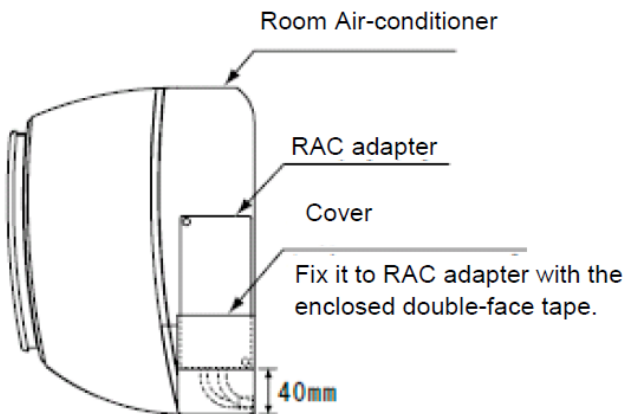

NOTE:

- Consider the following points since the adhesiveness changes according to the environmental conditions (temperature, humidity etc)
- The adhesiveness is decreased when there is humidity or oil.
- Warm the adhesive part and installation place of the two-sided tape to avoid the decrease of the adhesiveness in case the ambient temperature is low.
- DO NOT touch the adhesive part by fingers nor re-attach it many times. The adhesiveness has decreased and the RAC adaptor may fall off.
- DO NOT apply any force within 24 hours after installation.

10.2.3. ELECTRICAL WIRING

■ System configuration

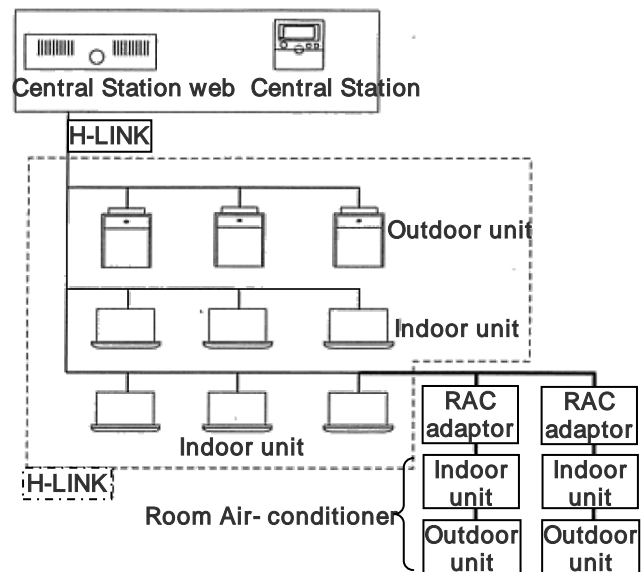

CAUTION:

- Turn OFF the power supply of the room air-conditioner of the central control device when performing the wiring work
- DO NOT run all the H-LINK cable or power supply cable along the other signal cable, or malfunction may occur due to the noise, etc. If it is required to run along the other transmission cable, separate the cable more than 30cm, or run the cable through the metal tube and earth the tube.
- Follow local codes and regulations when performing electrical wiring and earth wiring.
- Transmissions cable used in H-LINK shall be 2 cores cable (0.7mm² to 1.25mm² for model: VCTF, VCT, CVV, MVVX, CVVX, VVR, VVF) or 2 cores twisted pair cable (model: KPEV, KPEV-Spec). Total length of cable shall be below 1000mm.
- DO NOT use wire with more than 3 cores.

■ Internal components and Wiring connections

Check the contents and the number of the accessories in the packing.

- Access
 - Open the cover by removing the ① and ② screws.



- Wiring Connection
 - Connection with Room Air-Conditioner
 - i) Remove the front cover of the room air-conditioner and the cover of electrical box.
 - ii) The cable attached with the connector of the RAC adaptor shall be connected with the connector of indoor PCB

- iii) Install the electrical box cover paying attention not to clamp the cable. Read the installation manual of each room air-conditioner for confirming how to connect and how to assemble the cable of the RAC adaptor.

CAUTION:

- Disconnect the power plug before performing this work
- Turn OFF the break power source in case the power is supplied from the outdoor unit.

- Connection of Transmission Cable

H-LINK transmission cable connecting to RAC adaptor shall be connected to H-LINK.

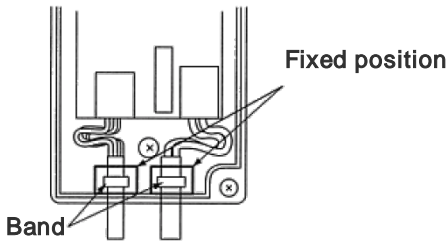
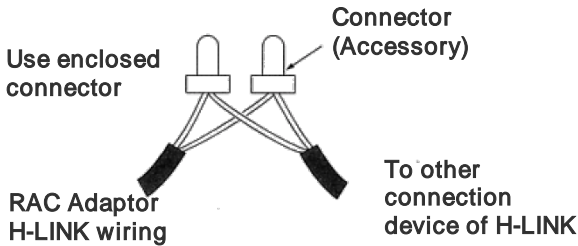

CAUTION:

- DO NOT connect incorrect wiring. It may cause the failure of the RAC Adaptor. Especially pay attention not to apply high voltage e.g. AC400/230V.
- DO NOT perform the wiring work while power to the central station or the RAC Adaptor is still being supplied. It may cause malfunction. Turn OFF devices when performing the wiring work.
- The RAC Adaptor side cable should not overload to the connector.
- DO NOT clamp the cable when attaching the RAC adaptor cover.
- Band should not be loose and in fixed position.

10.2.4. DIP SWITCH SETTING

- 1) Switch OFF the power of room air conditioner before setting the DIP switch. If the power is ON, the settings are INVALID.
- 2) The position of the DIP switch is shown below.

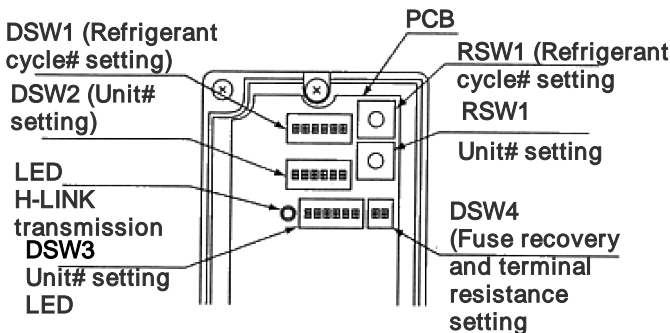

CAUTION:

- DO NOT turn ON various pins of DSW1 and DSW2

- 3) Set the refrigerant cycle# by RSW1 and DSW1

DSW1 (Ten digit)	RSW1 (Last digit)
DSW1 and RSW1 are set "0" before shipment. Up to 15 cycles can be set. E.g. Setting in Ref No. 5	
<p>No. 1 pin is OFF</p>	<p>The position is Set 5</p>

- 4) Set the unit No. by RSW2 and DSW2

DSW2 (Ten digit)	RSW2 (Last digit)
DSW2 and RSW3 are set "0" before shipment. Up to 15 cycles can be set. E.g. Setting in Unit No. 15	
<p>No. 1 pin is OFF</p>	<p>The position is Set 5</p>

- 5) Slave unit.

In case of setting various RAC adaptors in the same refrigerant cycle, set the RAC adaptor with smallest Unit# as a master unit. In case of setting only one RAC adaptor in a refrigerant system, this adaptor should be a master unit. Set this procedure by DSW3.

Master Unit setting	Setting before shipping (slave unit setting)

●: Master Unit setting

○: Setting before Shipping (Slave Unit setting)

		Indoor Unit#							
		0	1	2	3	4	5	6	7
Refrigerant Unit#	0	●	○	○	○	○			
	1			●	○	○			
	2				●	○	○	○	○
	3		●						
	4								

CAUTION:

– DO NOT set various main adaptors in the same refrigerant cycle.

- 6) Procedure when applying 200V voltage to H-LINK wiring incorrectly.

In case of applying 200V voltage to H-LINK wiring incorrectly, the fuse installed in a transmission circuit on PCB will blow out. In this case, reconnect the wiring correctly and turn ON No. 2 pin of DSW4 on PCB. The transmission circuit can be recovered. (If applying this error again, the transmission circuit can not be recovered)

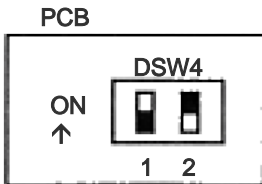

Turn ON No.2 pin of DSW4

- 7) Terminating resistance is set in whole H-LINK system.
 - a) If H-LINK connecting devices like package air-conditioner are connected besides the RAC Adaptor, set the terminating resistance by those connecting devices. The terminating resistance should be set ON in only one position in whole H-LINK system.
 - b) In case that H-LINK is connected only by the RAC adaptor, set the terminating resistance by the RAC adaptor. The terminating resistance should be set ON in only one position in whole H-LINK system.



Turn ON No.1 pin of DSW4

10.2.5. TEST RUN

Test run should be performed in the following after finishing the installation, wiring and setting. Refer to the installation manuals enclosed with the control system equipment.

- 1) Confirmation of RAC Adaptor Connection

Confirm if the RAC adaptor connection is recognized in the control system equipments. In case that it is not confirmed, check the transmission cable, refrigerant cycle #, indoor unit #, terminal resistance setting etc.
- 2) Registration

Confirm if the RAC adaptor connection is recognized.
- 3) Confirmation of RUN/STOP Operation.

Confirm if the room air-conditioner operate correctly by RUN/STOP from the central control system equipments. Check also if the room air-conditioner operation changes correctly by each setting.

10.3. DRY CONTACT (SPX-WDC3) APPLICATION (USING DIP SWITCH)

The dry contact system enables the operation of the air conditioner indoor unit to be controlled by using external dry contacts (with non voltage) such as card-key controller or window for facilities such as hotels.

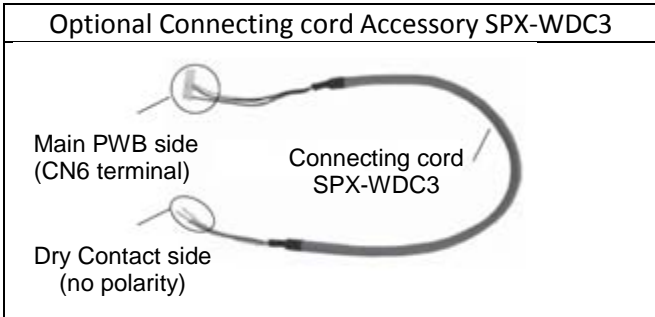

Note:

- 1) DRY CONTACT function is "Enable" by set pin No. 2 of the DIP SWITCH (DSW1) to ON position.
- 2) Select the proper setting for DRY CONTACT LOGIC INPUT pin No. 3 on DIP SWITCH (DSW1)
 - i) Set to OFF position (Hi Input) if the type of Dry Contact switch to be used (for the CARD KEY UNIT or Window) is of contact type a (Normally Open Type) as shown in below diagram.
 - ii) Set to ON position (Lo Input) if the type of Dry contact switch to be used (for the CARD KEY UNIT or Window) is of contact type b (Normally Close Type) as shown in below diagram.

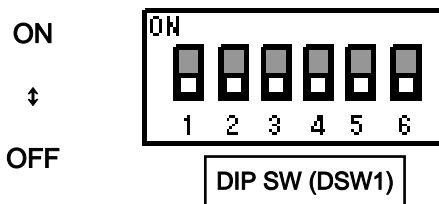

Pin No.	Function	Switch Position / Setting			
		OFF	Disable	ON	Enable
2	DRY CONTACT function	OFF	Disable	ON	Enable
3	DRY CONTACT Input Logic	OFF	HI Input Active	ON	LO Input Active

- Please decide the type of dry contact you will be using and set the position of the DIP Switch No. 2 and 3 accordingly

[1] CHECK DRY CONTACT OF CARD KEY UNIT

	AIR CONDITIONER Standby	AIR CONDITIONER Operating
	CARD KEY (Door Switch)	REMOVE
Contact type a	OPEN 	CLOSE
Contact type b	CLOSE 	OPEN

[2] SET THE POSITION OF DIP SWITCH

POSITION CONDITION OF DIP SWITCH	
<p>INITIAL CONDITION (CARD KEY NO USE) No.2 : OFF No.3 : OFF</p>	
<p>HI Input Active No.2 : ON No.3 : OFF</p>	
<p>LO Input Active No.2 : ON No.3 : ON</p>	

After all connection has been done as below diagram, ON the breaker and push ON button of wireless remote controller or wired remote controller to operate the air conditioner unit.

- When the CARD KEY is in insert condition, the air conditioner operation is allowable by remote controller.
- When the dry contact switch on the Card Key Unit is open (refer to diagram below for contact type a), the unit stops to operate (it takes 10 seconds to stop the unit operation after the dry contact switch on the card key turns off) and vice versa.
- When the card key is removed from the Card Key Unit, the wireless remote controller cannot be used.
- When the card key is removed from the Card Key Unit, the wired remote controller LCD display is activated; however it has no control over the unit.
- The suitable accessory Connecting Cord (accessory code#: SPX-WDC3) need to be used to connect the Card Key Unit's dry contact switch to the connector on the control board of the indoor unit

Example of wiring connection to Card Key Unit will be as below (reference only)

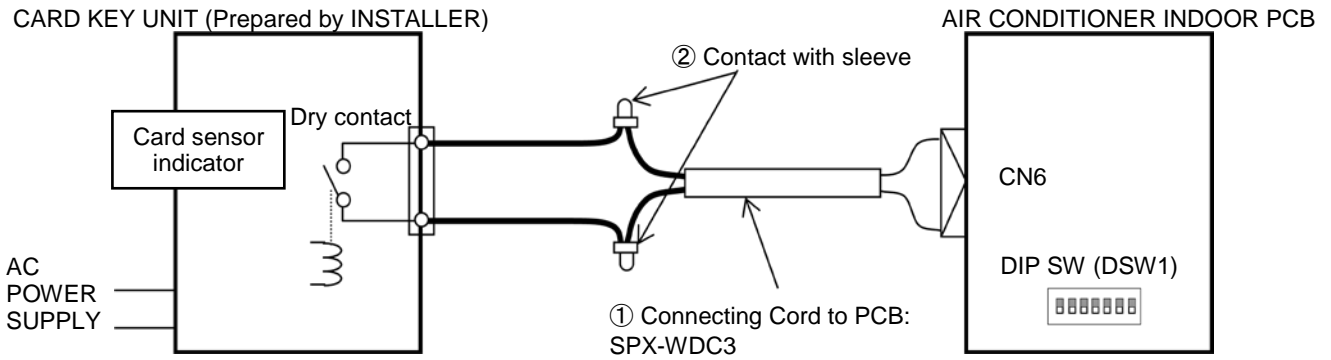

• CONNECTION EXAMPLE

i. Pin No. 3 of DIP SWITCH is set to OFF position (HI Input Active) for Dry Contact Type a

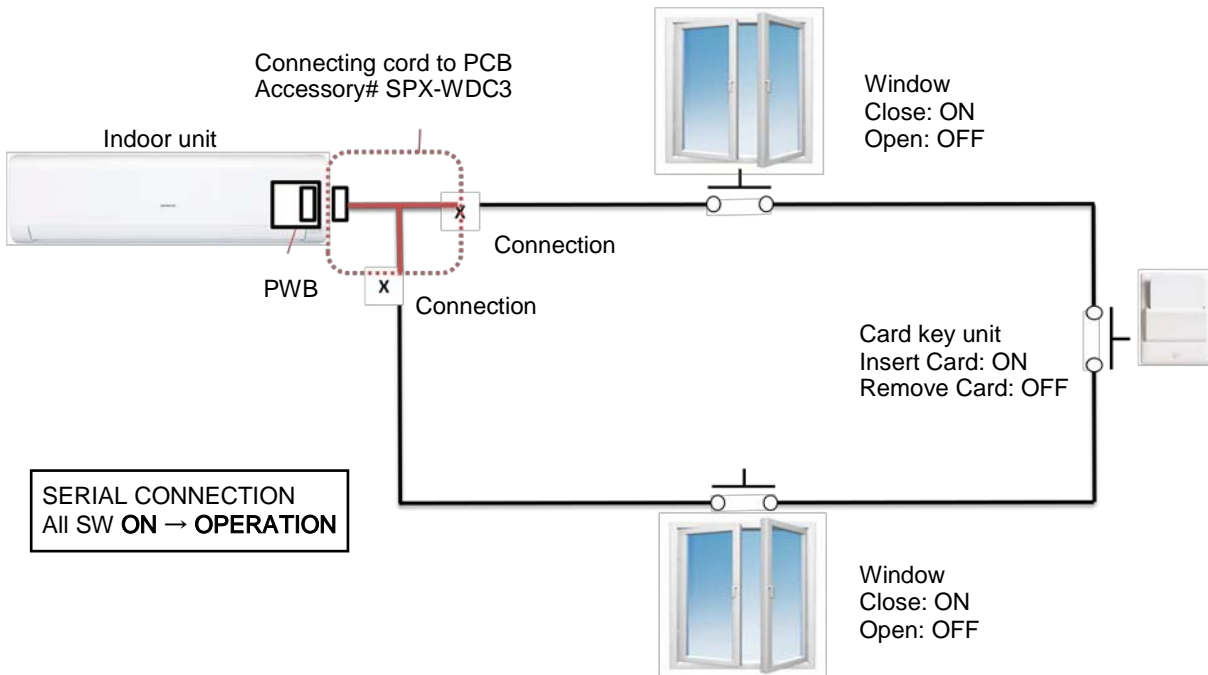

ii. Pin No. 3 of DIP SWITCH is set to ON position (LO Input Active) for Dry Contact Type b

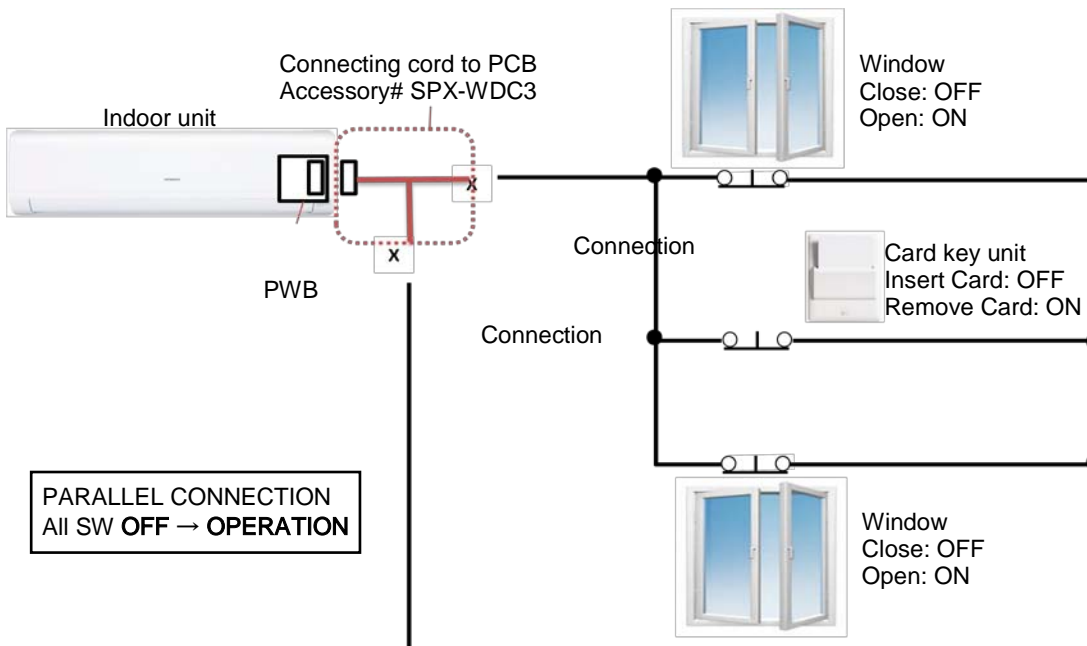

Please refer to the actual manual supplied with the optional connecting cords SPX-WDC3 for more details.

10.4. DISTRIBUTOR – SPX-DST1

The optional distributor is to be used together with the wired remote controller when there is a need to centralize the control of multiple indoor units using only a single wired remote controller.

A single distributor could be connected further to 3 separate distributors so that up to 13 units of indoor could be controlled by a single wired remote controller.

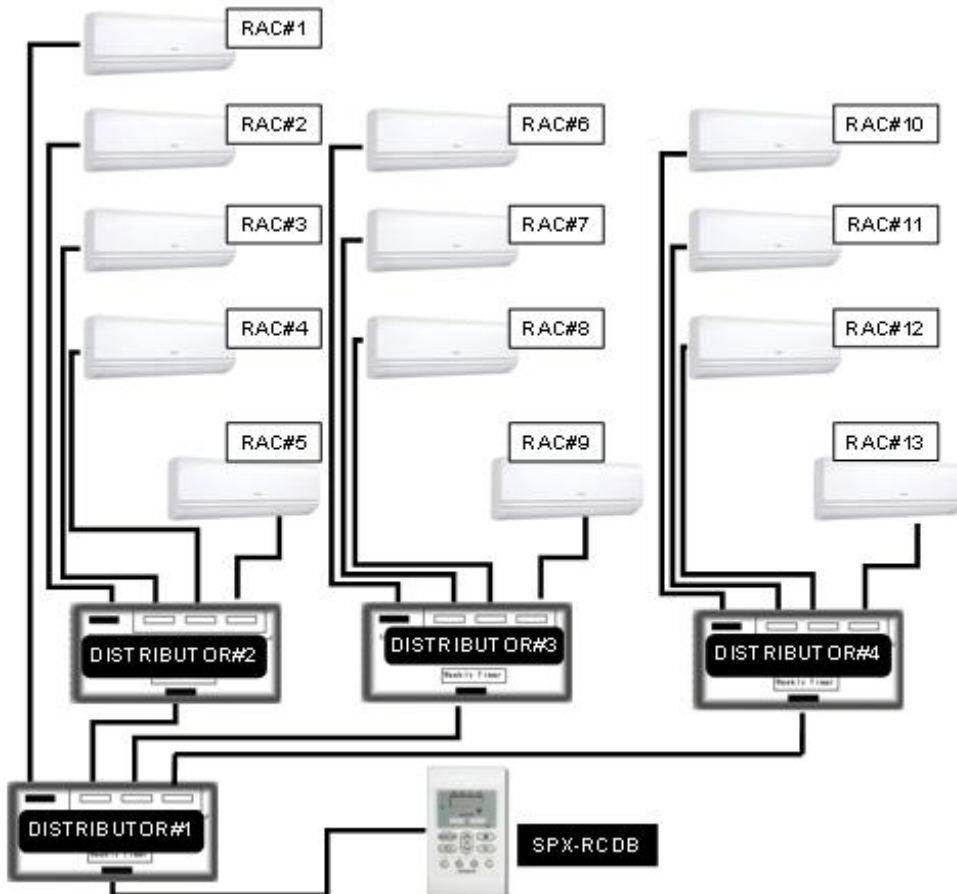
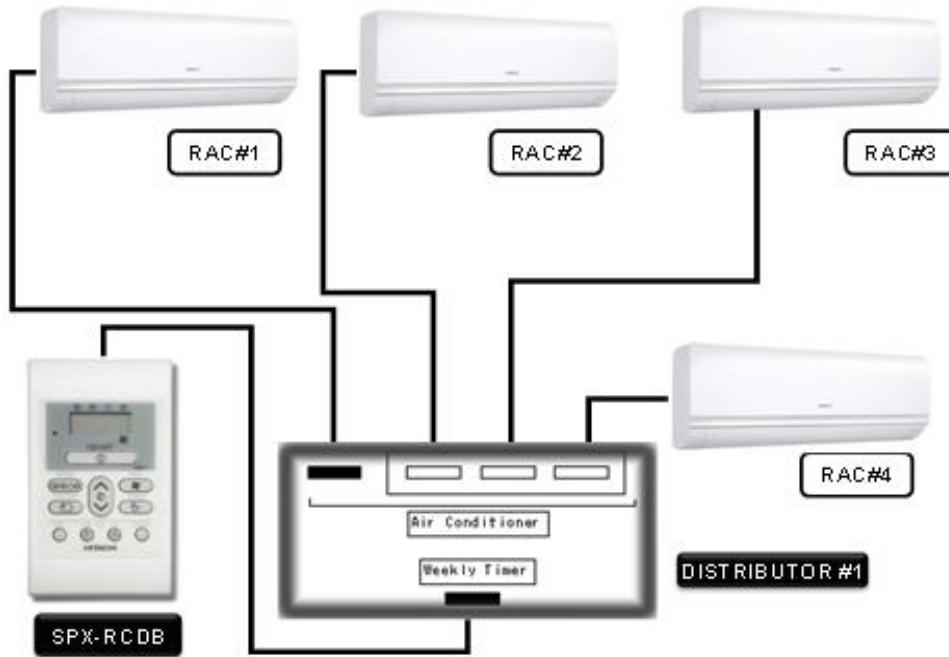

HITACHI

TC_ERP-RXB00-03/15